

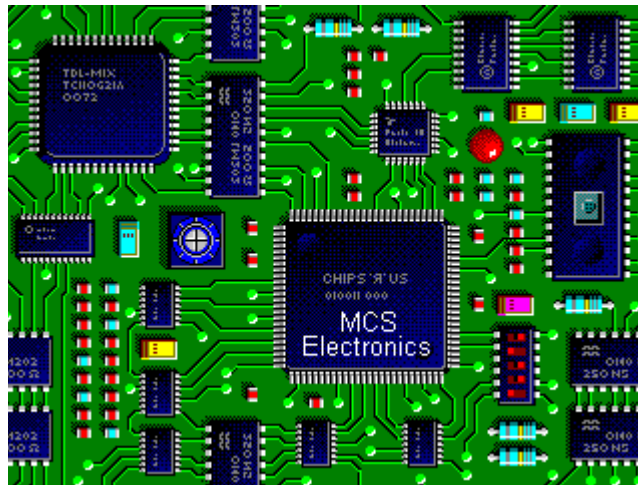

BASCOM-8051

The Windows 8051 BASIC Compiler



BASCOM-8051 User Guide
© 1995-1998 MCS Electronics

MCS Electronics may update this documentation without notice.
Products specification and usage may change accordingly.

MCS Electronics will not be liable for any mis information or errors found in this document.

All software provided with this product package is provided ' AS IS' without any warranty expressed or implied.

MCS Electronics will not be liable for any damages, costs or loss of profits arising from the usage of this product package.

No part of this document may be reproduced or transmitted in any form or by any means, Electronics or mechanical, including photocopying and recording, for any purpose without written permission of MCS Electronics.

Copyright MCS Electronics. All rights reserved.

©
Portions Copyright © 1992-1998 Silicon Studio Ltd.
<http://www.sistudio.com> a source of PINAPI drivers and programs.

International Distributors

<p>Scandinavia High Tech Horizon Christer Johansson E-mail cj@hth.com WWW http://www.hth.com</p>	<p>Hungary CODIX Ltd, Hungary. Imre Gaspar Phone +361 356 6330 Fax +361 356 4376 E-mail info@codix.hu WWW http://www.codix.hu</p>
<p>Swiss & Germany Dr.-Ing. Claus Kühnel Consulting & Distribution Phone +41 1 785 02 38 Fax +41 1 785 02 75 Email ckuehnel@access.ch WWW http://www.access.ch/ckuehnel</p>	<p>Italy GRIFO. Salvatore Damino Phone +39 (51) 892.052 Fax +39 (51) 893.661 E-mail tech@grifo.it WWW http://www.grifo.com (English) WWW http://www.grifo.it (Italian)</p>
<p>Australia & US Don McKenzie Dontronics Email don@dontronics.com WWW http://www.dontronics.com</p>	<p>Spain and Portugal Joaquim Boavida Multidigital, Lda P.O. Box 137 4435 Rio Tinto Portugal Email info@multidigital.com WWW http://www.multidigital.com Tel : +351 - 2 - 610 22 17 Fax : + 351 - 2 - 486 21 73</p>
<p>Slovenia AX Elektronika d.o.o. p.p. 5127 1001 Ljubljana Managing director : Jure Mikeln Tel: (+386-61)-14-914-00, -14-914-05 Fax: (+386-61)-485-688 Email: jure.mikeln@svet-el.si</p>	<p>Czech & Slovak LAMIA s.r.o. Porici 20 a 678 01 BLANSKO Czech republic Tel: 00420 506 418726 Fax: 00420 506 53988</p>
<p>Spain Ibercomp S.A. C/Parc, número 8 (Bajos) E07014 Palma de Mallorca España E-mail ibercomp@atlas-iap.es WWW http://www.ibercomp.es Tel : +34 (9) 71 45 66 42 Fax: +34 (9) 71 45 67 58</p>	<p>Korea SAMPLE Electronics Co. 413-72 kuro-2 kuro Seoul Korea E-mail info@sample.co.kr WWW http://www.sample.co.kr Tel : 82-2-857-4599 Fax: 82-2-857-6976</p>

<p>Croatia Adriatrade d.o.o. Jadranska 47 52470 Umag Managing director : Josip Stefek Tel: (+385-52)-752-658 Email: adriatrade@ad411.tel.hr</p>	<p>UK TECHMAIL SOLUTIONS LTD 14 Dunvegan Road Eltham London SE9 1SA Tel. 0171 343 5242 or 0181 488 9689 Fax.0171 821 6744 Email : dogan@dircon.co.uk</p>
--	---

Thank you for using BASCOM-8051, the Windows BASIC compiler for the AT89C2051 and other 8051 family members.

I want to thank a few people who helped me with parts of BASCOM :

Dr.-Ing. Claus Kühnel for his excellent translation of the documentation into the German language. Check his website : **<http://www.access.ch/ckuehnel>**

Antti from Silicon Studio for the use of his cheap BlowIT 89C2051 programmer design and software. You can check his site at **<http://sistudio.com>**

Jakub Jiricek for the use of his SPI-programmer design and software.

Francois du Plessis for the use of his improved SPI-programmer routines.

This guide will help you to install BASCOM and explains the environment briefly.

If you have questions, remarks or suggestions please let us know.

You can contact us by sending an Email to **mcselec@xs4all.nl**

Our website is at **<http://www.xs4all.nl/~mcselec>**

For info on updates : please read the readme.txt file !!!

Regards,

Mark Alberts
MCS Electronics

Installing BASCOM-8051

In the program manager from Windows, select **File, Run**, and then type **A:SETUP** . The following window will appear:

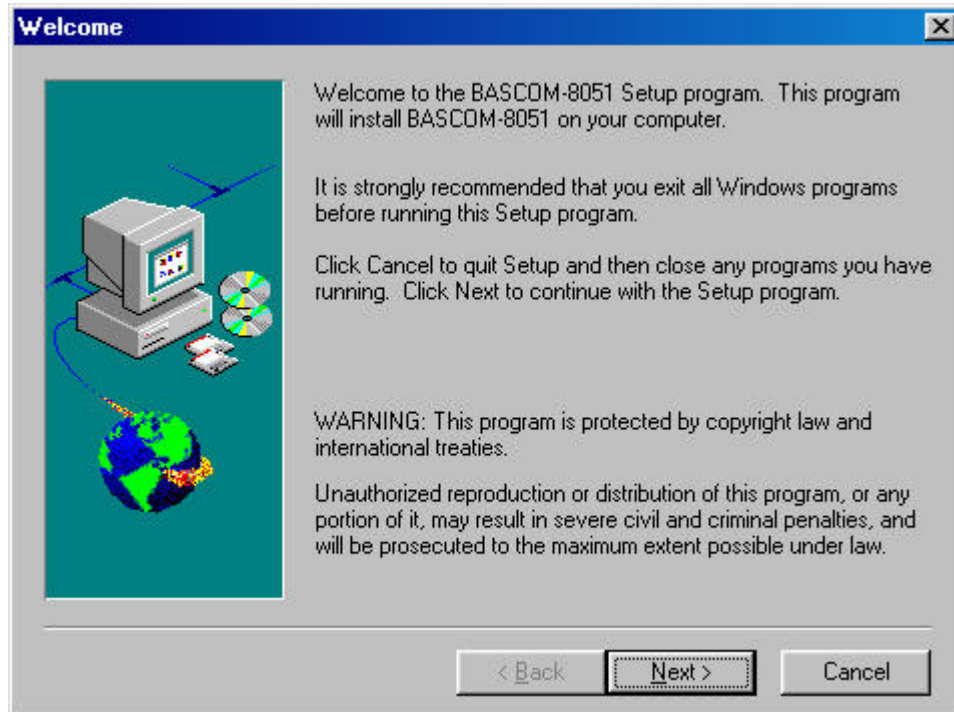

Click on the Next-button to continue installation.

The following window will appear :

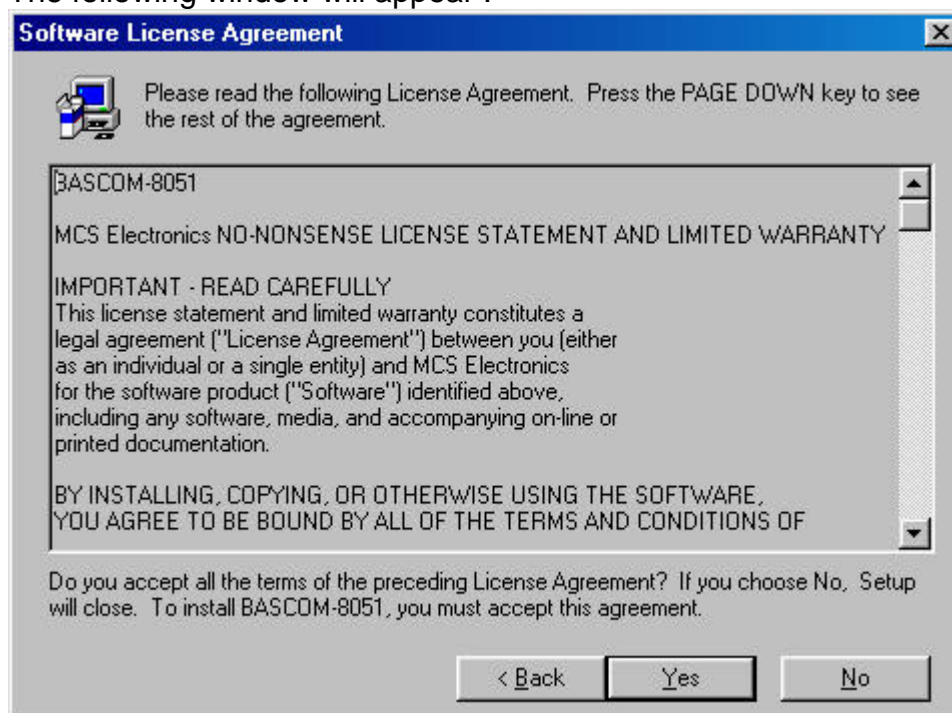

Read the license agreement and click the Yes-button

Now a window with additional information is displayed. This information will be installed as a readme.txt file too.

After reading the info once again click the Next-button.
Now the following window appears:



The image shows a Windows-style dialog box titled "User Information". On the left side, there is a graphic with a computer monitor, a CD-ROM, and a globe. To the right of the graphic, the text reads: "Type your name below. You must also type the name of the company you work for." Below this text are two text input fields. The first field is labeled "Name:" and contains the text "Mark Alberts". The second field is labeled "Company:" and contains the text "MCS Electronics". At the bottom of the dialog box, there are three buttons: "< Back", "Next >", and "Cancel".

Now fill in your name and company name.
Click the Next-button to continue.

Now you have the change to select the directory in which BASCOM will be installed.

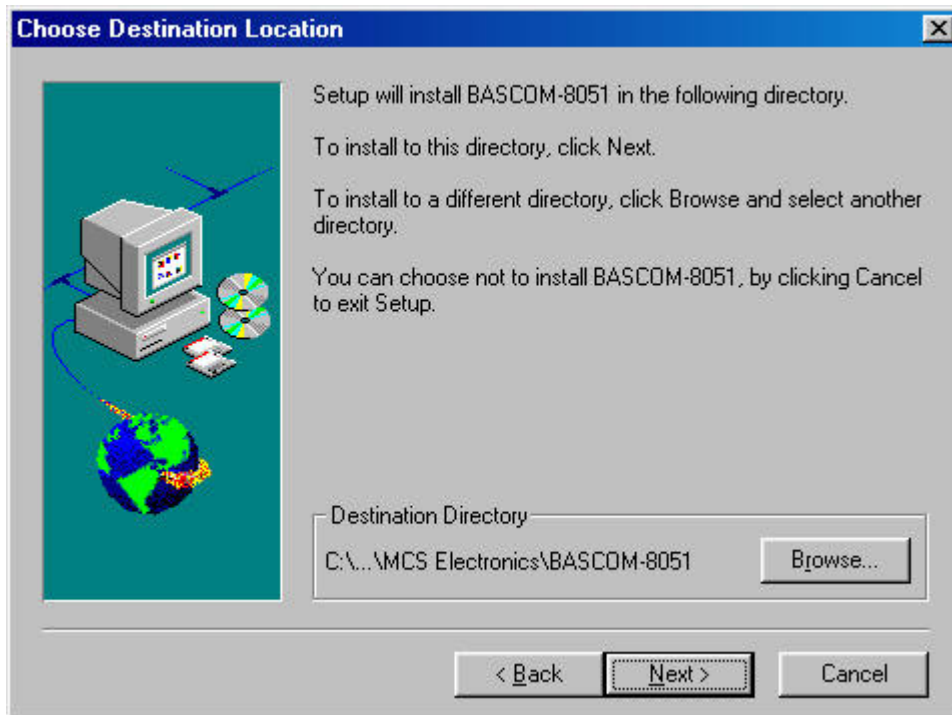

Select the Browse-button to change the directory path if required. By default BASCOM-8051 will be installed into **C:\Program Files\MCS Electronics\BASCOM-8051**

After selecting the installation directory click the Next-button. Now you will be asked in which program group the BASCOM-8051-icon must be placed. By default a new program group named MCS Electronics will be made.

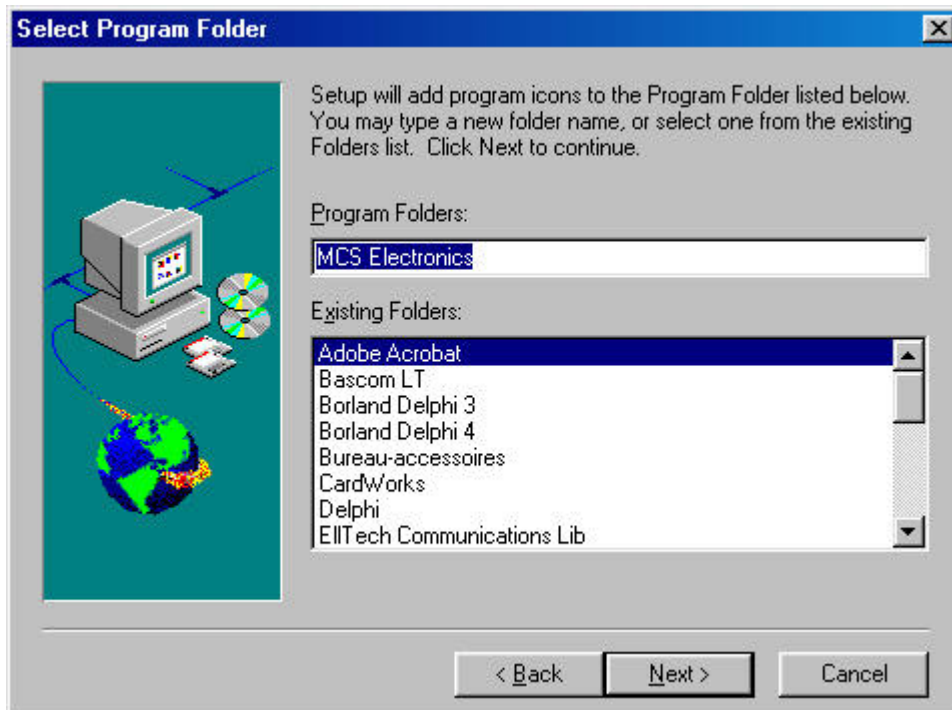

After selecting the group, click the Next-button to continue.

A summary will be showed and you have the change to go back to change your settings. Click the Next-button to install BASCOM-8051.

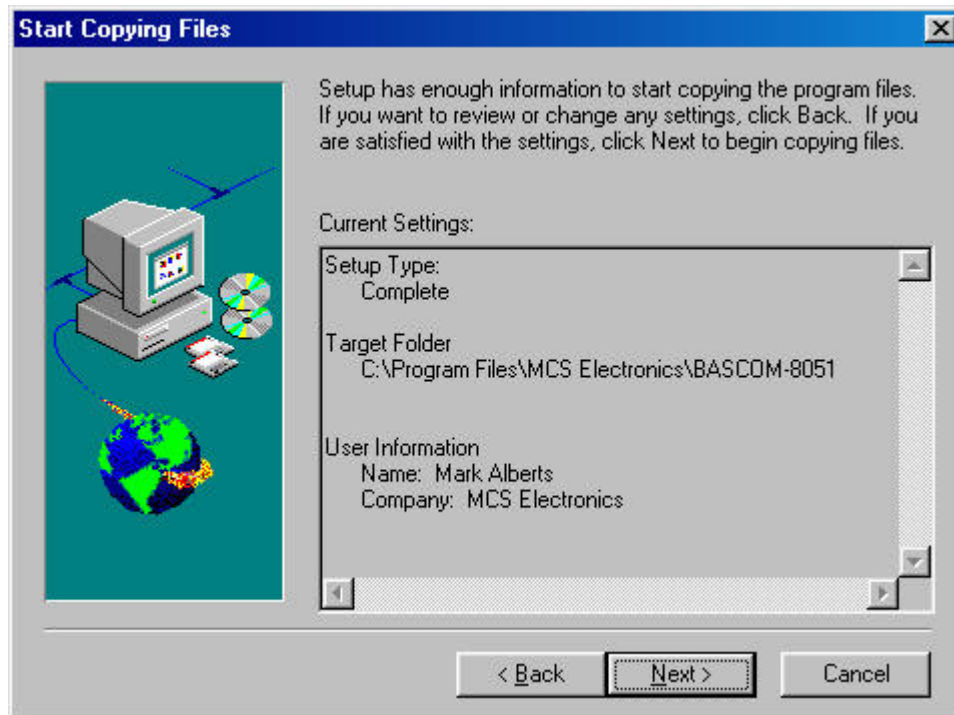

When the installation is completed you must click the Finish-button, and restart Windows.

A sub directory named SAMPLES contains all the BASCOM-8051 sample files.

*******IMPORTANT*******

The license file is not included in the setup. You must copy this file to the **WINDOWS\SYSTEM** directory from DOS or with Explorer. The license file is named **BSC5132L.DLL** and can be found on the last installation disk.

For DOS :
C:\COPY A:\BSC5132L.DLL C:\WINDOWS\SYSTEM

For Explorer:
Select the file from disk A and drag it into the WINDOWS\SYSTEM directory.

Of course the name of your system directory can be \W95\SYSTEM or \WINNT\SYSTEM too.

For NT, you should also install the TVICPORT driver by right-clicking on the icon and choose Install.

RUNNING BASCOM-8051

Double-click the BASCOM-8051 icon to run BASCOM.

The following window will appear. (or an empty edit window on your first run)

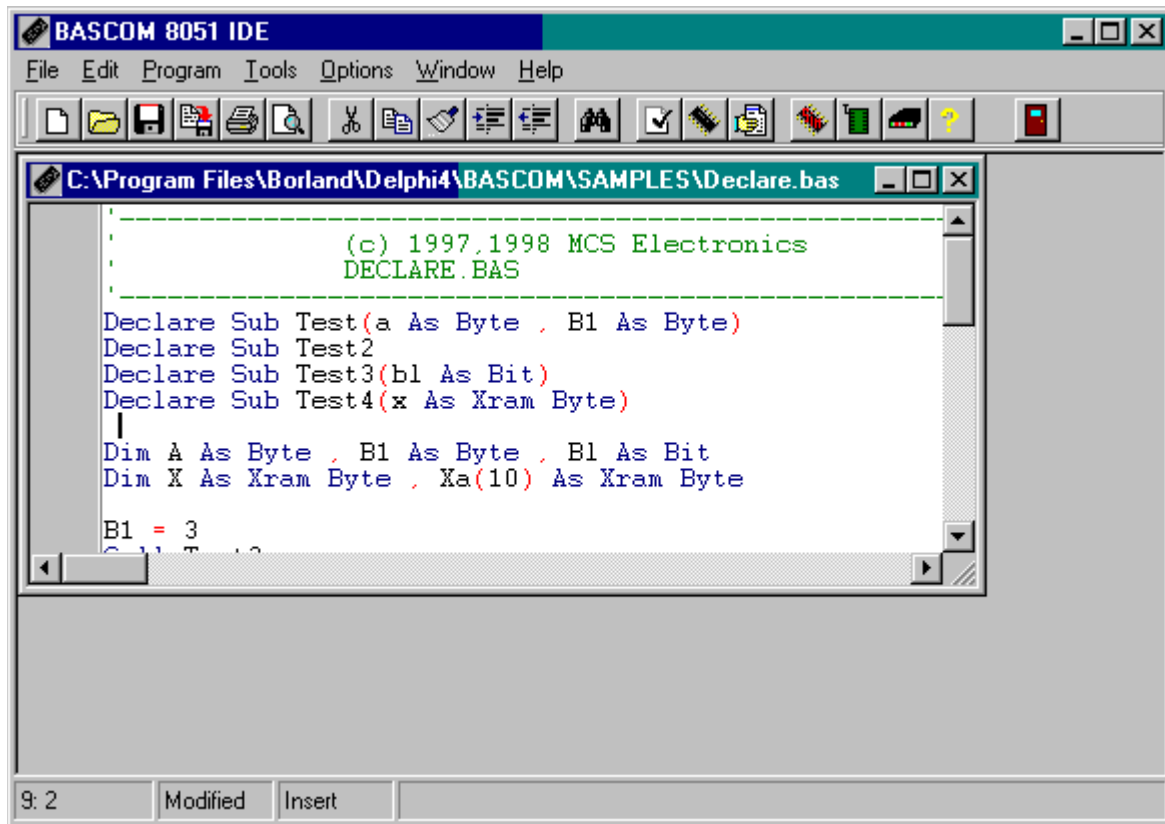

The last opened file will be loaded.

The menu options are described on the following pages.

File New

This option creates a new window in which you write your program. The focus is set to the new window.

File new shortcut :  , CTRL + N

File Open

With this option you can load an existing program from disk. BASCOM saves files in standard ASCII format. So if you want to load a file which is made with another editor be sure that it is saved as an ASCII file.

Note that you can specify that BASCOM must reformat the file when it opens it with the **Options Environment** option. This should only be necessary when loading files made with another editor.

File open shortcut :  , CTRL+O

File Close

Closes the current program. When you have made changes to the program you will be asked to save the program first.

File close shortcut : 

File Save

With this option you can quick save your current program to disk. If the program was created with the **File New** option you will be asked to name the file first. Use the **File Save As** option to give the file another name.

Note that the file is saved as an ASCII file.

File save shortcut :  , CTRL+S

File Save As...

With this option you can save your current program to disk.
You can enter a different name before the program is saved.

Note that the file is saved as an ASCII file.

File save as shortcut : 

File Print Preview

With this option you can preview the current program before it is printed.
Note that the current program is the program which has the focus.

File print preview shortcut : 

File Print

With this option you can print the current program.
Note that the current program is the program which has the focus.

File print shortcut :  , CTRL+P

File Exit

With this option you can leave BASCOM.
If you have made changes to your program, you can save them upon leaving
BASCOM.

File exit shortcut : 

Edit Undo

With this option you can undo the last textmanupulation.

Edit Undo shortcut :  , CTRL+Z

Edit Redo

With this option you can redo the last undo.

Edit Redo shortcut :  , CTRL+SHIFT+Z

Edit Cut

With this option you can cut selected text into the clipboard.

Edit cut shortcut :  , CTRL+X

Edit Copy

With this option you can copy selected text into the clipboard.

Edit copy shortcut :  , CTRL+C

Edit Paste

With this option you can paste text from the clipboard into the current cursor position.

Edit paste shortcut :  , CTRL+V

Edit Find

With this option you can search for text in your program.
Text at the cursorposition will be placed in the find dialog box.

Edit Find shortcut :  , CTRL+F

Edit Find Next

With this option you can search for the last specified search item.

Edit Find Next shortcut :  , F3

Edit Replace

With this option you can replace text in your program.

Edit Replace shortcut :  , CTRL+R

Edit Goto

With this option you can goto a line immediately.

Edit goto line shortcut :  ,CTRL+G

Edit Toggle Bookmark

With this option you can set/reset a bookmark, so you can jump in your code with the Edit Goto Bookmark option. Shortcut : CTRL+K + x where x can be 1-8

Edit Goto Bookmark

With this option you can jump to a bookmark.
The can be up to 8 bookmarks. Shortcut : CTRL+Q+ x where x can be 1-8

Edit Indent Block

With this option you can indent a selected block of text.

Edit Indent Block shortcut :  , CTRL+SHIFT+I

Edit Unindent Block

With this option you can unindent a block.

Edit Unindent Block shortcut :  , CTRL+SHIFT+U

Program Compile

With this option you can compile your current program.
Your program will be saved automatically before it will be compiled.
The following files will be created depending on the Option Compiler Settings.

File	
xxx.BIN	Binary file which can be programmed into the uP.
xxx.DBG	Debug file which is needed by the simulator.
xxx.HEX	Intel hexadecimal file which is needed by some programmers.
xxx.ERR	Error file. (only when errors are found)
xxx.RPT	Report file.

If an error occurs, you will receive an error message.

After you have pressed the Ok-button the cursor will be set to the line in which the error occurred. The margin will also display a  sign.

Program compile shortcut :  , F7

Program Syntax Check

With this option your program is checked for syntax errors. No file will be created except for an error file, if an error is found.

Program syntaxcheck shortcut , CTRL + F7

Program Show result

Use this option to view the result of the compilation.
See the **Options Compiler Output** for specifying which files must be created.
The files that can be viewed are report and error.

File show result shortcut :  , CTRL+W

Information provided in the report:

Info	Description
Compiler	The version of the compiler.
Processor	The selected targetprocessor.(dat file)
Date and time	The compilation date and time.
Baud timer	The timer used for generating the baudrate. 0 when no timer is used.
Baudrate and frequency	The baudrate selected for the uP and the used crystal. This info is used for RS232 related statements such as PRINT and INPUT. Note that when you use the \$crystal and \$baud statements the <u>exact</u> baudrate is shown.
ROM start	The starting location of the ROM code. Default 0.
RAM start	The starting location of the external RAM space. Default 0.
LCD mode	The mode the LCD display is used. 4 bit mode or 8 bit mode.
Stack start	The starting location of the stack. The space below the stack is used for variables. The stack grows when calls are made by the machine language routines.
Used ROM	Displays the length of the generated binary file.

Program Simulate

With this option you can simulate your program.
The simulator window looks like this:

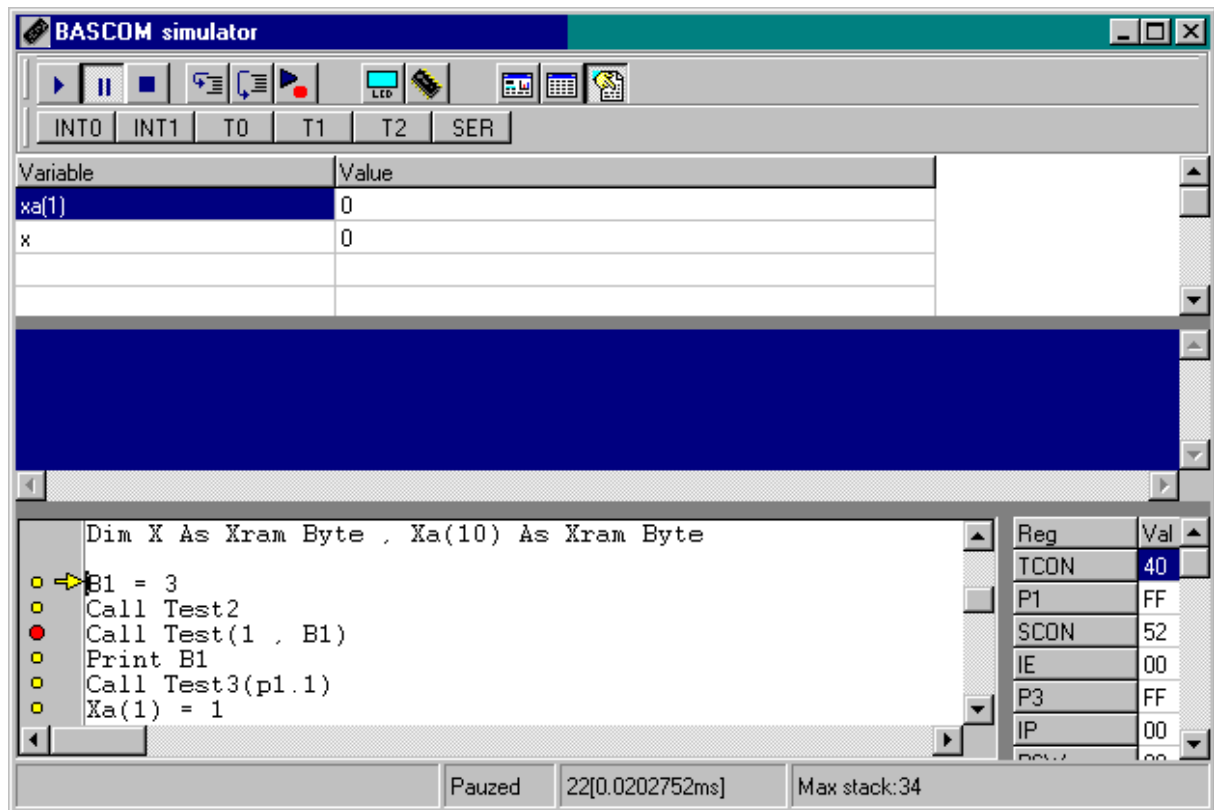

Click the Run-button to start the simulation.

The output (if any) is displayed in the middle blue colored section.
If input is required than you must set the focus to that section before entering the input. This only applies to PRINT and INPUT related statements.

To pause simulation, click the Pause-button  . Click the run-button again to continue.

Click the Stop-button  to stop execution.

Click the Step-button  to step through the program.

Click the Step over-button  to step over SUBS (GOSUB and CALL).

Select a line in the source window and click the run to-button  to run the program till the selected line. The simulator will pause at that point.

To watch the value of a variable, move the mousecursor over the variable name.
The value is displayed in the statusbar.

To add a variable to the watch window, select it and press return, or type it's name in the watch window.

To alter the value of a variable set the focus to the value and change the value.

The INT0, INT1, T0, T1 and SER button can be clicked to generate an interrupt.
Because this is a software emulator no hardware interrupts can be generated. You have to do this yourself by clicking these buttons. The TIMER interrupt is simulated.
Additional buttons can be displayed when the chip has additional interrupts.

Press the hardware simulation button  to enable the hardware simulation.

You need additional hardware to use this feature.

An application note can be downloaded that describes the hardware that is needed.

The hardware simulator will simulate port 1 and 3.

This way you can test your program in circuit without programming the device.

At the moment only the status reading and setting of the ports is supported.

This means that interrupts are not yet supported in hardware simulation.

By clicking the hardware simulation button  , the following window is displayed.

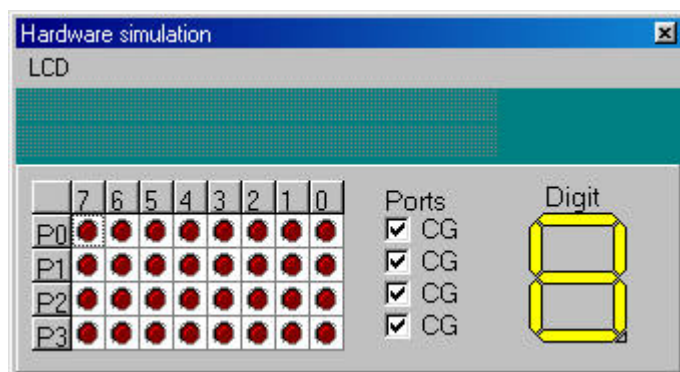

The upper section emulates a LCD display. Select the proper type from the menu.
The lower section emulates port 0-3 and a LED display.

By clicking on the LEDS, you can switch them on or off.

By right clicking on the LED display, you can define to which port pins the segments are connected.

On the right side of the code window, the SFR's are displayed. You can alter them just like the normal variables.

During simulation you can set breakpoints by pressing F9. A breakpoint can only be set on a line which contains executable code. This is notated by a small yellow dot. When a breakpoint is selected, a red dot is displayed.

A blue arrow shows the line executing.

Program Simulate shortcut :  , F2

Program Send to chip

This option will bring up the selected programmer or will program the chip directly if this options is selected from the Programmer options.

Program send to chip shortcut  , F4

Tools Terminal Emulator

With this option you can communicate via the RS-232 interface to the microcomputer. The following window will appear :

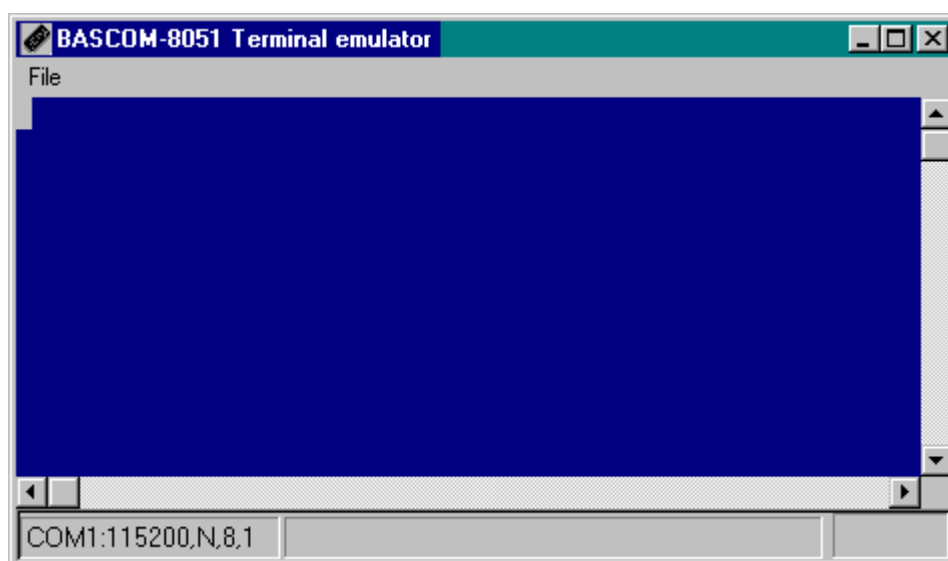

Information you type and information that the computer board sends, are displayed in the same window.

Note that you must use the same baud rate at both sides. If you compiled your program with the Compiler Settings at 4800 baud, you must set the Communication Settings also to 4800 baud. The setting for the baud rate is also reported in the report file.

File Upload

Uploads the current program in HEX format. This option is meant for loading the program into a monitor program.

File Escape

Aborts the upload to the monitor program.

File Exit

Closes terminal emulator.

Tools LCD designer

With this option you can design special characters for LCD-displays. The following window will appear:

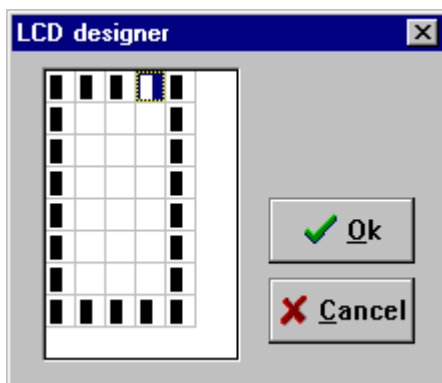

The LCD-matrix has 7x5 points. The bottom row is reserved for the cursor but can be used. You can select a point by double-clicking the left

mousebutton. If a cell was selected it will be deselected. When you are finished you can press the Ok-button : a statement will be inserted in your active program-editor window at the current cursorposition. The statement looks like this :

```
Deflcdchar ?,1,2,3,4,5,6,7,8
```

You must replace the ?-sign with a character number ranging from 0-7.

See Deflcdchar in the helpfile.

Options Compiler

With this option you can modify the compiler options.

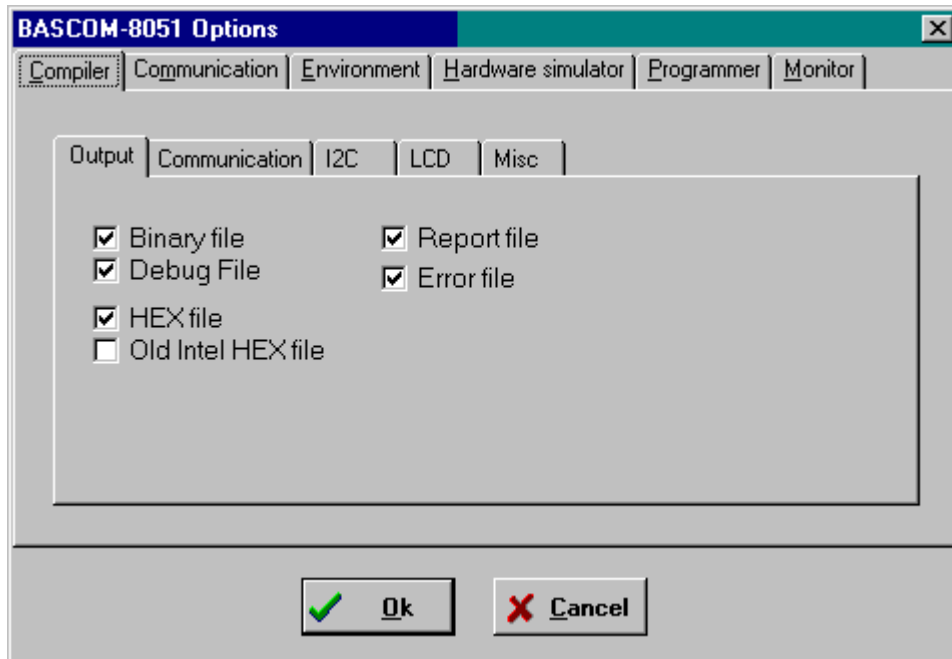

The following options are available (by selecting the specified tab):

TAB	OPTION	DESCRIPTION
Output	Binary file	Generates a binary file.
	HEX file	Generates an Intel Hexadecimal file.
	DEBUG file	Generates a debug and map file needed by the simulator.
	Report file	Generates a report file.
	Error file	Generates an error file if an error occurs.
	Old Intel Hex	Generates an old Intel hex file use by some monitors.
Communication	Baudrate	The baudrate that the RS232 routines like PRINT and INPUT uses to communicate with your computer.
	Frequency	The frequency of the uP crystal on you uP-board.
I2C	SCL port	The pin that is used for the SCL-line needed by the I2C routines.
	SDA port	The pin that is used for the SDA-line needed by the I2C routines.
LCD	RC5 port	The pin that is used for the GETRC5 statement.
	DB4-DB7, ENABLE, RS	The port pins that are connected to the LCD display.
MISC	Register file	The name of the SFR register file.
	Byte End	The last position in RAM that can be used for internal variables. The stack will start at ByteEnd + 1. When you run out of stack space you must decrease this value, this also means that there is less space for variables.
	Size warning	Size of ROM code that is allowed. Bigger code will give a warning.
	Compiler	Select the BASCOM-8051 or the BASCOM LT compatibility compiler.

Options Communication

With this option you can modify the communication settings for the terminal emulator.

Item	Description
Comport	The comport of your PC to use.
Baudrate	The baudrate to use.
Parity	Parity, default None.
Databits	Number of databits, default 8.
Stopbits	Number of stopbits, default 1.
Handshake	Handshake used, default none.
Emulation	Emulation used, default BBS ANSI.
Font	Font type and color used by the emulator.
Backcolor	Backgroundcolor of the terminal emulator.

Note that the baudrate of the terminal emulator and the baudrate setting of the compiler options, must be the same in order to work correctly.

Options Environment

With this option you can modify the environment options.

OPTION	DESCRIPTION
Auto Indent	When you press return, the cursor is set to the next line at the current column position
Don't change case	When set, the reformatter won't change the case of the text. Default the text is reformatted so every word begins in uppercase.
Reformat BAS files	Reformat files when loading them into the editor. This is only necessary when you are loading files that were created with another editor. Normally you won't need to set this option.
Reformat code	Reformat code when entered in the editor.
Smart TAB	When set, a TAB will go to the column where text starts on the previous line.
Syntax highlighting	This options highlights BASCOM statements in the editor.
Tooltips	Show tooltips.
Show toolbar	Shows the toolbar with the shortcut icons.
Size of new editor window	When a new editor window is created you can select how it will be made. Normal or Maximized (full window)
Editor font	Click on this label to select another font for the editor window.
Comment	The position of the comment. Comment is positioned at the right of your source code.
TAB-size	Number of spaces that are generated for a TAB.
Background color	The backgroundcolor of the editor window.
Keymapping	Choose default, Classic, Brief or Epsilon.

No reformat extension	File extensions separated by a space that will not be reformatted when loaded.
-----------------------	--

Options Hardware Simulator

With this option you can modify the hardware simulator settings.

OPTION	DESCRIPTION
Simulator LPT	Portaddress of the printer port that is attached to the sim.
Simulator delay	Delay for the simulator in milli seconds. For fast PC's only.

Options Programmer

With this option you can modify the programmer settings.

OPTION	DESCRIPTION
Programmer	Select one from the list.
Auto flash	Some programmers support auto flash. Pressing F4 will program the chip without showing the programmer window.
Auto verify	Some programmers support verifying. The chipcontent will be verified after programming.
LPT address	Port address of the LPT that is connected to the programmer.
Port delay	Delay, only for Blow IT programmer.
PCF8574A	Only for MCS Flashprogrammer or simulator. Select when you use these chips instead of the PCF8574.
Send HEX	Only for EPROM Simulator on LPT. Select when a HEX file must be sent instead of the bin file.

Options Monitor

With this option you can modify the monitor settings.

OPTION	DESCRIPTION
Monitor	Select the monitor program used.
Other	Will shell to a external program. Of course it must accept the filename as a parameter.

Options Printer

With this option you can modify the printer settings.

OPTION	DESCRIPTION
--------	-------------

Left	The left margin.
Right	The right margin.
Top	The top margin.
Bottom	The bottom margin.

Window Cascade

Cascade all open editor windows.

Window Tile

Tile all open editor windows.

Window Arrange icons

Arrange the icons of the minimized editor windows.

Window Minimize all

Minimize all open editor windows.

Help About

This option shows an about box as showed below.

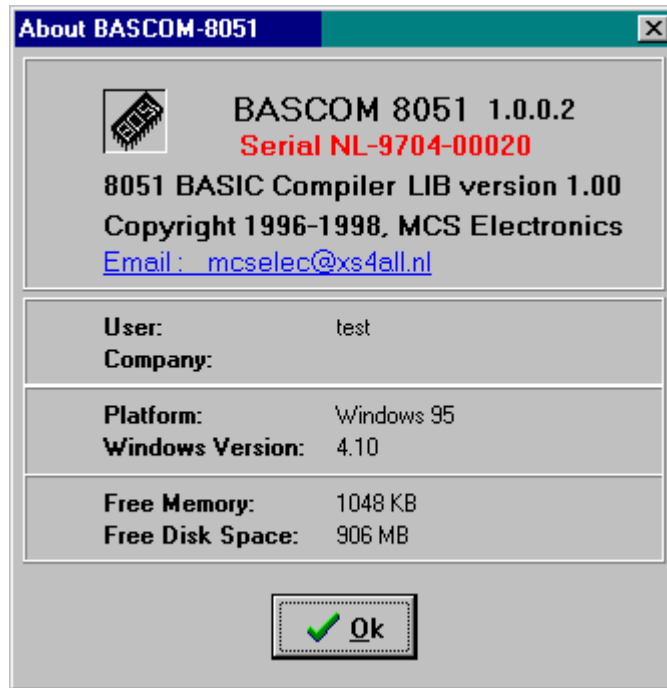

Your serialnumber is shown in the about box.
You will need this when you have questions about the product.
The libraryversion is also shown. In this case it is **1.00**.
You can compare it with the one on our website in case you need an update.

Click on **Ok** to return to the editor.

Help Index

Brings up the BASCOM help file.
When you are editing, the current word will be used as a keyword.

Help on help

Shows help on how to use the Windows help system.

Help Credits

Shows a form with credits to people I like to thank for their contributions to BASCOM.

Editor Keys

Key	Action
LEFT ARROW	One character to the left
RIGHT ARROW	One character to the right
UP ARROW	One line up
DOWN ARROW	One line down
HOME	To the beginning of a line
END	To the end of a line
PAGE UP	Up one window
PAGE DOWN	Down one window
CTRL+LEFT	One word to the left
CTRL+RIGHT	One word to the right
CTRL+HOME	To the start of the text
CTRL+END	To the end of the text
CTRL+ Y	Delete current line
INS	Toggles insert/overstrike mode
F1	Help (context sensitive)
F3	Find next text
CTRL+O	Load File
CTRL+S	Save File
F7	Compile File
CTRL+P	Print File
CTRL+T	Terminal emulator
CTRL+M	File Simulation
CTRL+A	Flash programmer
CTRL+F	Find text
CTRL+P	Compiler Options
CTRL+W	Show result of compilation
CTRL+X	Cut selected text into clipboard
CTRL+INS	Copy selected text into clipboard
SHIFT+INS	Copy text from clipboard into editor
Select text	Hold the SHIFT key down and use the cursor keys to select text. or keep the left mouse key pressed and tag the cursor over the text to select.

Developing order

start BASCOM;
open a file or create a new one;
check the baudrate and frequency settings for the target system;
compile the file;
if an error occurs fix it and recompile (F7);
run the simulator and check if you don't run out of stack space;
program the chip;

Memory

Every variable uses memory.

The available memory is 128 bytes. (or 256 bytes for some chips)

From these 128 bytes a maximum of 32 are used for internal registers.

Some bytes are used by the stack. This depends on the statements you have used.

Each 8 used bits occupy 1 byte.

Each byte occupy 1 byte.

Each integer/word occupies 2 bytes.

Each Long/Single occupies 4 bytes.

Use bytes when you can. (not allowed for negative values)

If your program use less than 64 bytes you can use an 89C1051 as well. This chip only doesn't have an UART for PRINT and INPUT statements.

Error codes

The following table lists errors that can occur.

Nr	Error message
1	BASIC sourcefile not found
2	Code does not fit into FLASHROM
3	Unknown statement
4	Extension expected
5	Wrong variable or variable not dimensioned
6	Two parameters expected
7	No more space for BIT
8	No more space for BYTE
9	No more space for INTEGER
10	Wrong type (BIT,BYTE or INTEGER) expected
11	AS expected by DIM
12	, expected
13	Unknown interrupt
14	IF THEN expected
15	FOR, DO or WHILE expected
16	Wrong number of parameters
17	Illegal compare (=,>,<,<>,<=,>=) expected
18	THEN expected
19	TIMER0 or TIMER1 expected
20	DO expected
21	UNTIL expected
22	Illegal mathematical operation
23	FOR expected
24	WHILE expected
25	Variable not dimensioned
26	Source file not found
27	Label not found
100-134	These are internal assembler warnings. Contact MCS Electronics .
135	Too many RAM used
136	Variable already dimensioned
137	Constant must be in range of 1-8
138	Baudrate not supported with selected frequency
139	9 parameters expected
140	COUNTER0 or COUNTER1 expected.
141	= expected.
142	Maximum of 128 ALIAS statement allowed.
143	Duplicate label
144	Value does not fit into byte(byte can store 0-255)

Hardware

You can attach additional hardware to the ports of the microprocessor.
The following statements will become available :

I2CSEND and I2CRECEIVE and other I2C related statements.
LCD, LCDHEX, DISPLAY and other related LCD-statements.

See the compiler settings for selecting the SDA (data) and SCL(clock) pins.

The LCD-display must be connected as following:

LCD-DISPLAY	PORT	PIN
DB7	P1.7	14
DB6	P1.6	13
DB5	P1.5	12
DB4	P1.4	11
E	P1.3	6

RS	P1.2	4
RW	Ground	5
Vss	Ground	1
Vdd	+5 Volt	2
Vo	0-5 Volt	3

This leaves P1.1 and P1.0 and P3 for other purposes.

You can change these settings from the Options LCD menu.

The LCD-display operates in 4-bit mode.

BASCOM supports a lot of statements to control the LCD-display.

For those who want to have more control the example below shows how to.

```
Acc = 5           'load register A with value
Call Lcd_control  'it is a control value to control the display
Acc = 65         'load with new value (letter A)
Call Write_lcd    'write it to the LCD-display
```

Note that `lcd_control` and `write_lcd` are assembler subroutines which can be called from BASCOM.

See manufacture details from your LCD display for the correct assignment.

I2C

The design below shows how to implement an I2C-bus.

R1 and R2 are 330 ohm resistors.

R3 and R4 are 10 kilo-ohm resistors.

Note that you can select which port pins you want to use for the I2C interface with the compiler settings.

A PCB board with RS-232 interface, I2C interface, EEPROM 2404 and I/O expander PCF8574 is also available. Please inform for prices.

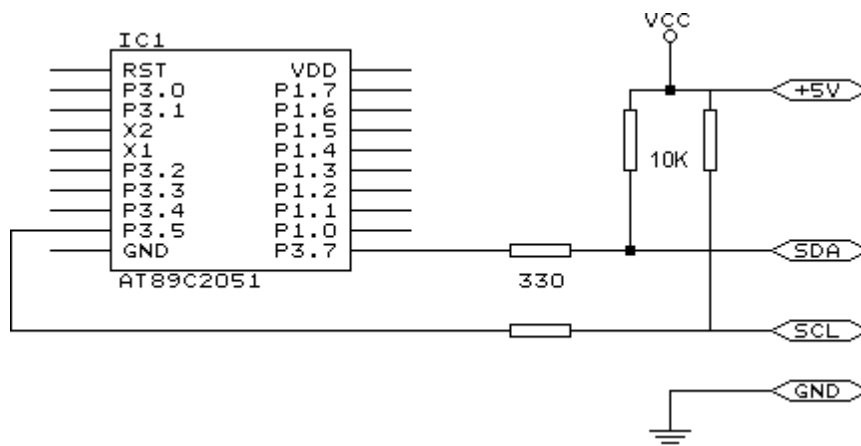

Hardware related commands

The uP must be connected to a crystal. The frequency of the crystal can range from 0 to 24 Mhz (for AT89Cx051).

The frequency is divided by 12 internally. So with a 12 Mhz crystal the processor is clocked with 1 Mhz.

Because almost each instruction takes 1 clockcycle to execute the processor can handle 1 MIPS.

When RS-232 statements such as INKEY, PRINT and INPUT are used, TIMER1 is connected to the systemclock. So TIMER1 can't be used for other purposes such as ON TIMER1 anymore. When no RS-232 related statements are used you can use TIMER1.

The Baudrate is generated by dividing the systemclock. When a crystal of 11.0592 Mhz is used, the Baudrate can be generated very accurately. Other crystals can be used also but the generated baudrate will never be exactly 2400 or 4800 baud and higher baudrates are almost impossible. Use the \$BAUD = xx and \$CRYSTAL = xx statements to specify your own settings. The exact baudrate will be shown in the report.

Clock

The clock frequency is the system frequency divided by 12. With a 12 Mhz crystal this means that every microsecond the register is incremented.

Timers and Counters

The AT89C2051 has two 16-bit timers. Named TIMER0 and TIMER1. Below the internal representation of timer0 is shown. TIMER0 and TIMER1 are almost identical so you can read TIMER1 for TIMER0.

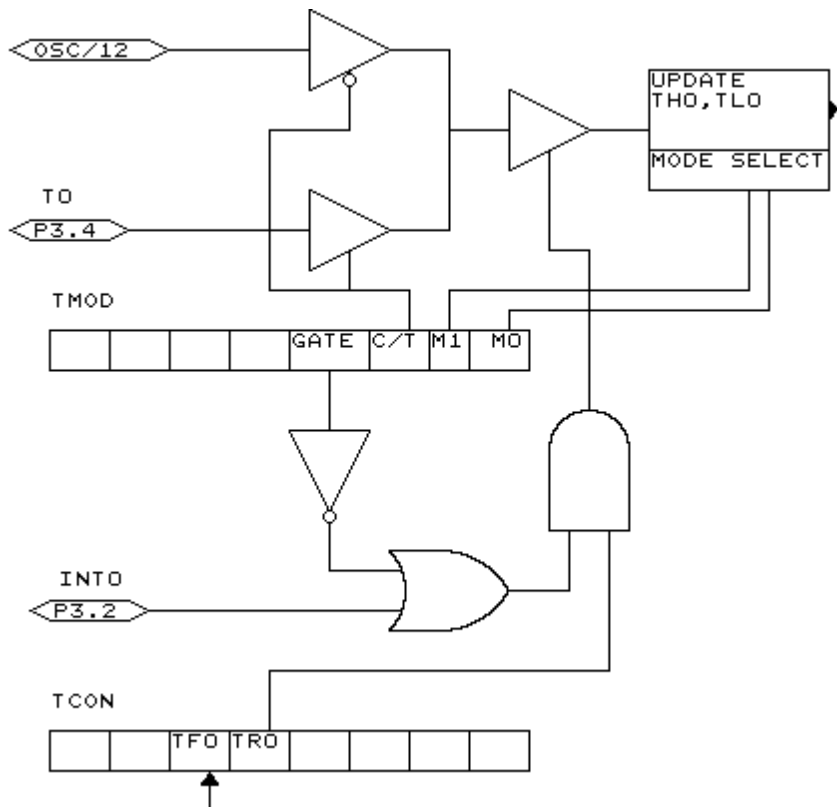

Each counter register has two SFR's associated with it. For TIMER0 the SFR's are TL0 and TH0. TL0 is the lowest byte of TIMER0 and TH0 is the highest byte of TIMER0. These two registers make the timers 16-bit wide.

The timer can operate as a timer or as a counter.

A timer uses the system clock divided by 12 as the source of its input pulses. So it increments periodical.

A counter uses external pulses to increment its count.

The external pulses are received at alternative pin P3.4 for TIMER0 and P3.5 for TIMER1.

The timer/counter can be controlled by the run-bit TR0.

You can stop a timer/counter with the statement `STOP TIMER0/COUNTER0`.

You can start a timer/counter with the statement `START TIMER0/TIMER1`.

The timer/counter can also be controlled with the alternative pin P3.2.

This pin is labeled for its alternative INT0-input but it can be used to control the timer. When GATE is reset the timer/counter is enabled. When GATE is set the timer/counter is enabled if INT0 is active(low). (provided that the timer is started)

The timer/counter can operate in four modes:

mode 0 : 13-bit counter.

An interrupt is generated when the counter overflows. So it takes 8192 pulses to generate the next interrupt.

mode 1 : 16-bit counter.

Mode 1 is similar to mode 0. It implements a 16-bit counter. It takes 65536 input pulses to generate the next interrupt.

mode 2 : 8-bit auto reload.

TL0 serves as an 8-bit timer/counter. When the timer/counter overflows the number stored in TH0 is copied into TL0 and the count continues.

An interrupt is generated each time the counter overflows and a reload is performed.

mode 3 : TIMER1 is inactive and holds its count. (TIMER1). For TIMER0 in timer mode two 8-bit timers are available and in counter mode one 8-bit timer is available. See a datasheet for more details.

The timer/counter can be configured with the CONFIG statement.

CONFIG TIMER0= COUNTER/TIMER, GATE=INTERNAL/EXTERNAL, MODE=0/3

The first argument is the timer/counter you want to configure.

GATE specifies if external timer control with the INT0 pin is enabled.

MODE specifies the timer/counter mode (0-3).

So CONFIG TIMER0 = COUNTER, GATE = INTERNAL, MODE=2 will configure TIMER0 as a COUNTER with not external gatecontrol , in mode 2 (auto reload)

When the timer/counter is configured the timer/counter is stopped so you must start it afterwards with the START TIMER0 statement.

The ON TIMERx statement can be used to respond to a timer/counter interrupt when the timer overflows.

When the timer/counter is used in mode 2 (auto reload) the reload value can be specified with the **LOAD TIMERx, value** statement.

Because it is an 8-bit register a maximum time of 255 uS can be achieved.

So for a period of 10 uS you must supply a value of (256-10) is 246. To make things easier you can assign the value directly : LOAD TIMERx , 250 will internally be transformed into 256-250=6. This saves you the trouble of calculating the correct value.

The COUNTER0 and COUNTER1 variables hold the values of timer/counter 0 and 1. You can also set the timer/counter contents with the COUNTER0 = value statement.

Port 3 is a unique port because it has alternative functions.

That is you can use it as a port like P3.1 = 1 or SET P3.1 or you can make use of the double function of this port.

Port	Alternative function
P3.0	RxD receive data for RS-232
P3.1	TxD transmit data for RS-232

P3.2	INT0 interrupt 0 input/timer 0 gate control
P3.3	INT1 interrupt 1 input/timer 1 gate control
P3.4	T0 timer 0 input or counter input
P3.5	T1 timer 1 input or counter input
P3.5	-
P3.7	-

When you make use of the PRINT, INPUT and other RS-232 related statements P3.0 and P3.1 are used for the RS-232 interface.

When you make use of the INT0/INT1 interrupts you must connect an interrupt source to the corresponding pins. A switch for example. The INTx interrupt can occur on the falling edge of a signal or when the signal is low. Use the following statements to specify the trigger:

SET TCON.0	falling edge generates interrupt for INT0.
RESET TCON.0	low signal generates interrupt for INT0.
SET TCON.2	falling edge generates interrupt for INT1.
RESET TCON.2	low signal generates interrupt for INT1.

When TCON.x is RESET the interrupts keep on occurring while the input is low. When TCON.x is SET the interrupt only occurs on the falling edge.

To test if a hardware interrupt is generated you can test the TCON.1 and TCON.3 flags. These flags are set by hardware when an external interrupt edge is detected. They are reset by the RETURN statement of the interrupt service routine or subroutine. TCON.1 must be tested for INT0 and TCON.3 must be tested for INT1.

Internal Registers

You can manipulate the register values directly from BASIC. They are also reserved words. The internal registers are :

BIT addressable registers

TCON	Timer/counter control
P1	Port 0 latch
SCON	Serial port control
IE	Interrupt enable
P3	Port 3 latch
IP	Interrupt priority control
PSW	Program status word
ACC	Accumulator
B	B register

BYTE addressable register

SP	Stack pointer
DPL	Data pointer low word
DPH	Data pointer high word
PCON	Power control

TMOD	Timer/counter mode control
TL0	Timer/counter 0 low byte
TL1	Timer/counter 1 low byte
TH0	Timer/counter 0 high byte
TH1	Timer/counter 1 high byte
SBUF	Serial data port
P1	Port 1 latch
P3	Port 3 latch

The registers and their addresses are defined in the REG51.DAT file which is placed in the BASCOM application directory.

You can add your own files for uP's that have more registers. These files must have the .DAT extension.

The REG51.DAT file must be selected when you compile for the AT89X051, 8051 or other 8051 compatible uP.

Take care when you are directly manipulating registers!

The ACC and B registers are frequently used by BASCOM.

Also the SP register is better to leave untouched. Altering SP will certainly crash your application!

Bit addressable registers can be used with the SET/RESET statements and as bit-variables.

Byte addressable registers can be used as byte variables.

P1 = 40 will place a value of 40 into port 1.

Please note that internal registers are reserved words. This means that they can't be dimensioned as BASCOM variables!

So you can't use the statement **DIM B as Byte** because **B** is an internal register.

You can however manipulate the register with the B = value statement.

Power Up

At power up both ports are high. When you want to read a value from a port it must be high!

So when you have set a port to zero and you want to use it as an input you must first set it to 255.

Individual bits can also be set to use a port both as input/output.

For example : P1 = **&B00001111** , will set a value of 15 to port 1.

P1.0 to P1.3 can be used as inputs because they are set high.

In line assembly

You can also use inline assembly language with BASCOM.

Assembler comment must be preceded by the ;-sign.

For example :

```
Dim a as byte  
mov {a}, #10 ; variables must be enclosed with { }  
Print a
```

Or you can include an assembler file :

```
$INCLUDE myasm.asm
```

Note that the file must have the extension .ASM

Initialization

BASCOM initializes the processor depending on the used statements.

When you want to handle this by yourself you can specify this by the metastatement

\$NOINIT.

The only initialization that is always done is the setting of the stackpointer and the initialization of the LCD-display (if statements are used).

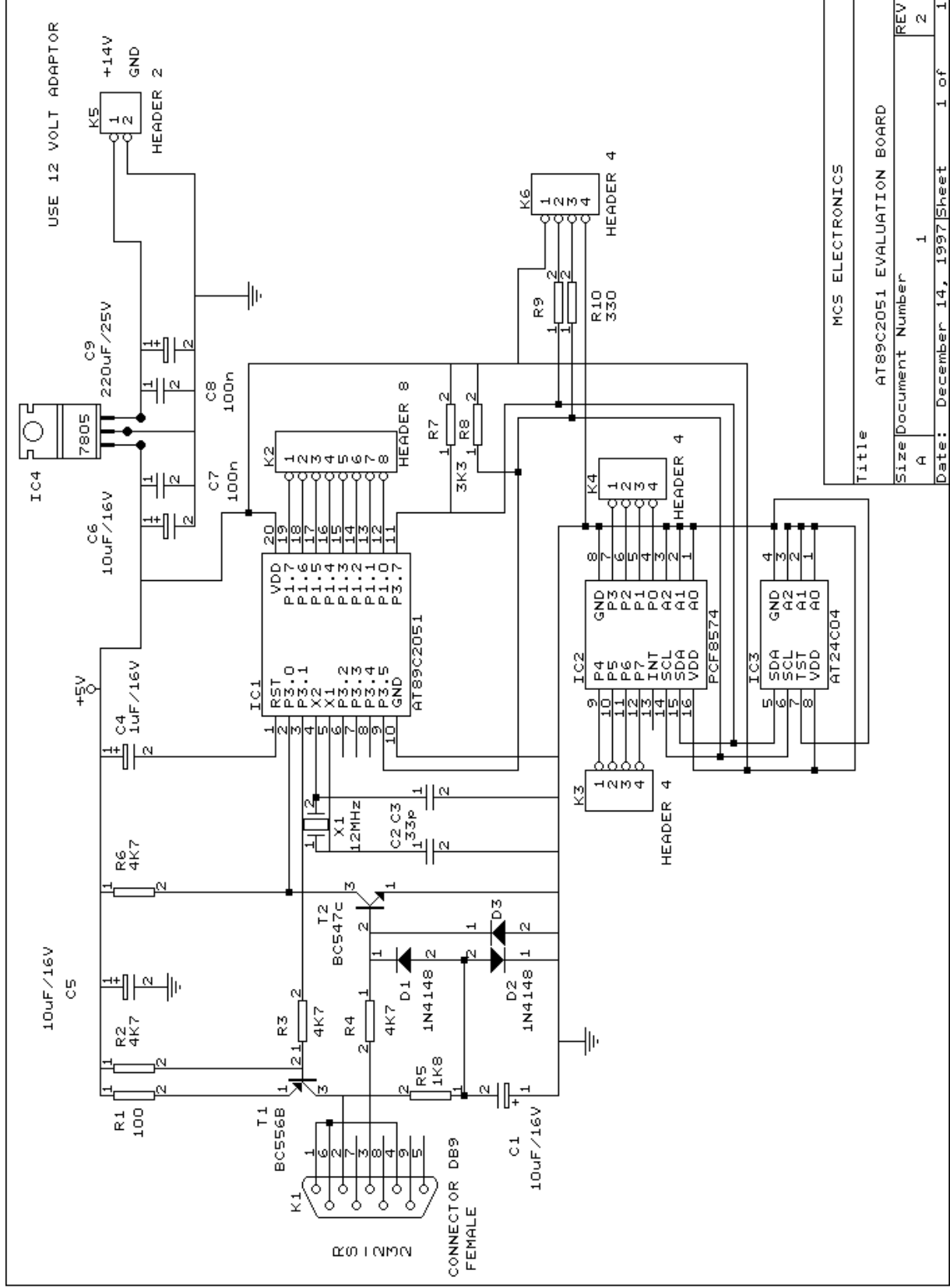

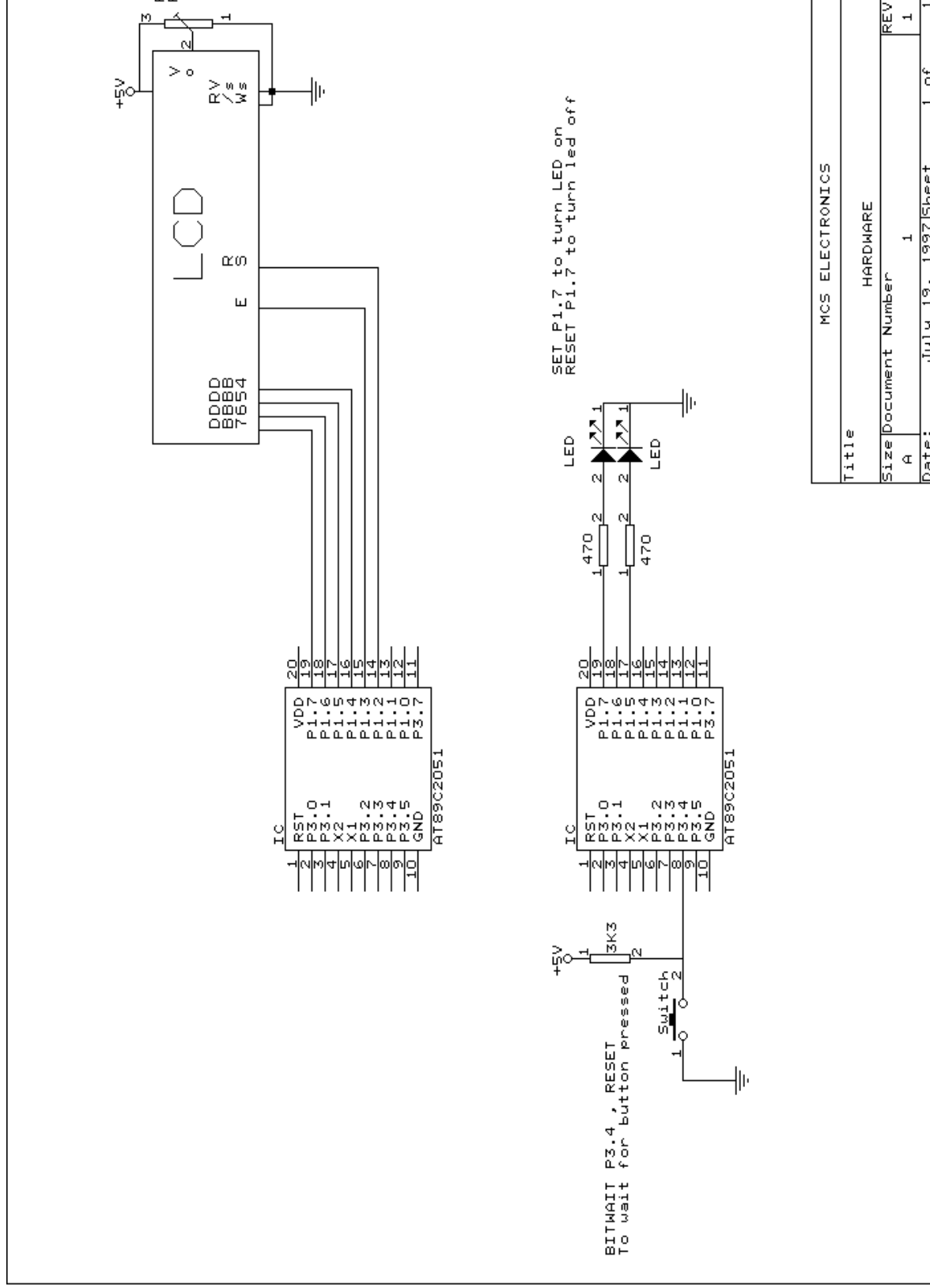

Title		MCS ELECTRONICS
Size		A
Document Number		1
REV	1	1
Date:	July 19, 1997	Sheet 1 of 1

D

Developing order 27

E

Edit Copy 13
Edit Cut 13
Edit Find Next 14
Edit Goto 14
Edit Goto Bookmark 14
Edit Indent Block 14
Edit Paste 13
Edit Redo 13
Edit Replace 14
Edit Search 13
Edit Toggle Bookmark 14
Edit Undo 13
Edit Unindent Block 15
Editor Keys 26
Error codes 28

F

File Close 11
File Exit 12
File New 11
File Open 11
File Print 12
File Print Preview 12
File Save 11
File Save As.. 12

H

Hardware 29
Hardware related commands 30
Help About 24
Help Credits 25
Help Index 24
Help on help 25

I

I2C 30
In line assembly 35
Initialization 35
Installing BASCOM-8051 6
Internal Registers 33

O

Options Communication 21
Options Compiler 20
Options Environment 21
Options Hardware Simulator 22
Options Monitor 23
Options Printer 23
Options Programmer 22

P

Power Up 34

Program Compile	15
Program Send to chip	18
Program Show result	15
Program Simulate	16
Program Syntax Check	15

T

Tools LCD designer	19
Tools Terminal Emulator	19

W

Window Arrange icons	23
Window Cascade	23
Window Minimize all	24
Window Tile	23