

GMM AC Zero

grifo® Mini Modulo AT89C51CC03

TECHNICAL MANUAL

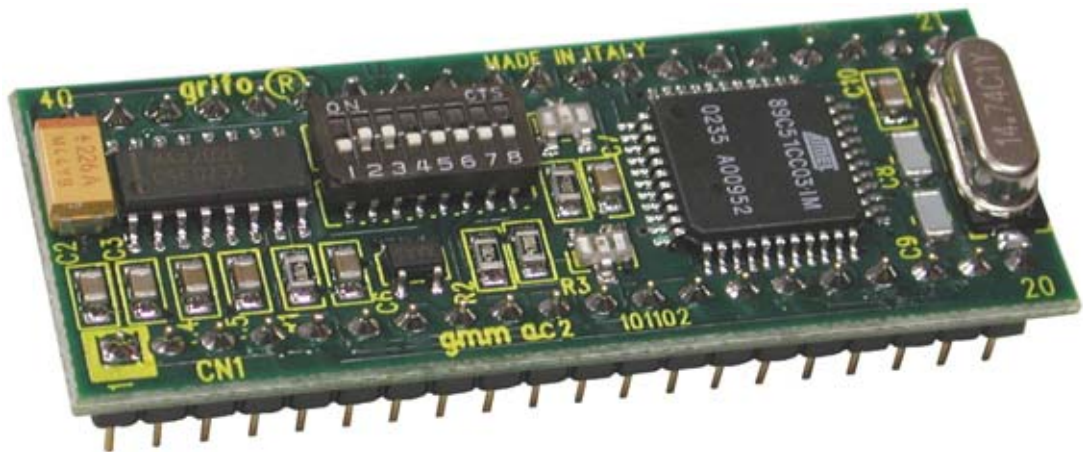

grifo®
ITALIAN TECHNOLOGY

Via dell' Artigiano, 8/6
40016 San Giorgio di Piano
(Bologna) ITALY
E-mail: grifo@grifo.it



<http://www.grifo.it> <http://www.grifo.com>
Tel. +39 051 892.052 (a. r.) FAX: +39 051 893.661

GMM AC Zero Rel. 5.00 Rel. 20 September 2004

, GPC®, grifo®, are trade marks of grifo®



GMM AC Zero

grifo® Mini Modulo AT89C51CC03

TECHNICAL MANUAL

Standard container with **40** pins male socket, DIL, 100 mils pitch, 600 mils width; very small dimension: 20.8 x 53.5 x 12.8 mm; **4 layers** PCB to obtain best noisy resistance and best **EMI** performance; single power supply required +5Vdc (the current consumption may vary according to module connections); availability of **Idle Mode** and **Power Down Mode**; **Atmel AT89C51CC03** microcontroller (8051 code compatible) with **14.74 Mhz** crystal; programmable machine speed at **12 or 6 clock** cycle; **64K FLASH** for code, **2K FLASH for Boot Loader**, **256 bytes IRAM** for data, **2K ERAM** for data, **2K EEPROM** for data; **8 A/D** converter channels with **10 bits** resolution, **20 µsec** conversion time; 14 interrupt sources with 4 priority levels; **3 Timers Counters** up to 16 bits; **5 PCA** channels up to 16 bits with **PWM**, watch dog, compare, capture, etc. functionality; **34 digital I/O** lines available on connector; hardware serial line with Baud Rate up to 115200 Baud, at TTL level or buffered **RS 232** with protection against ±15 kV discharges; **UART CAN** compatible with 2.0 A and 2.0 B standards that can be connected to an external CAN buffer; **reset** and power supply control circuit. Software **PC BUS** line, available on connector; 8 configuration dip switches; **2** status LEDs managed by software; internal FLASH and EEPROM can be managed through **ISP** (In System Programming), or when the module is already mounted, by using the serial communication line. **Software** for PC, that supports the ISP programming to download the generated code, inside on board FLASH; wide range of development tools as: **C** Compiler (µC/51, MCC51, HTC51, SYS51CW, DDS Micro C51); **BASIC** Compiler (BASCOM 8051); **PASCAL** Compiler (SYS51PW); etc.. Long list of demo programs and use examples supplied under source form, duly remarked, for the available development tools.

grifo®
ITALIAN TECHNOLOGY

Via dell' Artigiano, 8/6
40016 San Giorgio di Piano
(Bologna) ITALY
E-mail: grifo@grifo.it



<http://www.grifo.it> <http://www.grifo.com>
Tel. +39 051 892.052 (a. r.) FAX: +39 051 893.661

GMM AC Zero Rel. 5.00 Rel. 20 September 2004

, **GPC**®, **grifo**®, are trade marks of **grifo**®

DOCUMENTATION COPYRIGHT BY **grifo**[®], ALL RIGHTS RESERVED

No part of this document may be reproduced, transmitted, transcribed, stored in a retrieval system, or translated into any language or computer language, in any form or by any means, either electronic, mechanical, magnetic, optical, chemical, manual, or otherwise, without the prior written consent of **grifo**[®].

IMPORTANT

Although all the information contained herein have been carefully verified, **grifo**[®] assumes no responsibility for errors that might appear in this document, or for damage to things or persons resulting from technical errors, omission and improper use of this manual and of the related software and hardware.

grifo[®] reserves the right to change the contents and form of this document, as well as the features and specification of its products at any time, without prior notice, to obtain always the best product.

For specific informations on the components mounted on the card, please refer to the Data Book of the builder or second sources.

SYMBOLS DESCRIPTION

In the manual could appear the following symbols:



Attention: Generic danger



Attention: High voltage



Attention: ESD sensitive device

Trade Marks

, GPC[®], **grifo**[®] : are trade marks of **grifo**[®].

Other Product and Company names listed, are trade marks of their respective companies.

GENERAL INDEX

INTRODUCTION	1
CARD VERSION	2
NOTE ABOUT MINI MODULE NAME	2
GENERAL INFORMATION	3
DIGITAL I/O LINES	4
I²C BUS LINES	6
A/D CONVERTER ANALOG SIGNALS	6
MEMORY DEVICES	6
WATCH DOG	8
BOARD CONFIGURATION	8
CLOCK	8
SERIAL COMMUNICATION	9
TECHNICAL FEATURES	10
GENERAL FEATURES	10
PHYSICAL FEATURES	10
ELECTRIC FEATURES.....	11
INSTALLATION	12
VISUAL SIGNALATIONS	12
CONNECTIONS	12
CN1 - EXTERNAL MINI MODULE SIGNALS CONNECTOR	13
CONNECTOR SIGNALS INTERFACEMENT	14
DIP SWITCH	14
INTERRUPTS MANAGEMENT	16
SUPPORT CARDS	18
USE WITH GMB HR168 MODULE	18
USE WITH GMM TST 2 BOARD	20
HOW TO START	21
POWER SUPPLY	31
MEMORY ARCHITECTURE	31
OPERATING MODE SELECTION	31
SERIAL COMMUNICATION SELECTION	32
UART CAN	33
SOFTWARE DESCRIPTION	34
PERIPHERAL DEVICES SOFTWARE DESCRIPTION	35
CONFIGURATION INPUTS	35
STATUS LEDS	35
EXTERNAL DEVICES	36

BIBLIOGRAPHY 39

APPENDIX A: DATA SHEET A-1

APPENDIX B: GMM TST 2 ELECTRIC DIAGRAM..... B-1

APPENDIX C: ALPHABETICAL INDEX C-1



FIGURE INDEX

FIGURE 1: LOCATION OF REVISION NUMBER AND CARD NAME	2
FIGURE 2: BLOCK DIAGRAM	5
FIGURE 3: MODULE GMM AC ZERO	7
FIGURE 4: COMPONENTS MAP	9
FIGURE 5: TOP VIEW OF MINI MODULE GMM AC ZERO	11
FIGURE 6: LEDs TABLE	12
FIGURE 7: SOCKET AND MINI MODULE SIGNALS	13
FIGURE 8: DIP SWITCH	15
FIGURE 9: LEDs, DIP SWITCH, ETC. LOCATION	16
FIGURE 10: GMB HR168 AND GMM AC ZERO	17
FIGURE 11: GMM TST EXPERIMENTAL CARD WITH GMM AC ZERO INSTALLED	19
FIGURE 12: RS 232 POINT TO POINT CONNECTION TO A PC EXAMPLE	21
FIGURE 13: FLIP SETTINGS WINDOW (1 OF 3)	22
FIGURE 14: EXAMPLES TABLE	23
FIGURE 15: FLIP SETTINGS WINDOWS (2 OF 3)	24
FIGURE 16: FLIP SETTINGS WINDOWS (3 OF 3)	24
FIGURE 17: LOADING A SOURCE FILE WITH BASCOM 8051	26
FIGURE 18: CONFIGURATION OF COMPILER BASCOM 8051	26
FIGURE 19: COMPILATION WITH BASCOM 8051	27
FIGURE 20: LOADING SOURCE FILE WITH μ C/51	27
FIGURE 21: LOADING MAKEFILE (COMPILING CONFIGURATION) WITH μ C/51	28
FIGURE 22: COMPILATION USING μ C/51	28
FIGURE 23: LOADING SOURCE SCHEMATIC WITH LADDER WORK	29
FIGURE 24: COMPILER CONFIGURATION FOR LADDER WORK	29
FIGURE 25: COMPILATION WITH LADDER WORK	30
FIGURE 26: EXAMPLE OF RS 232 SERIAL CONNECTION	32
FIGURE 27: EXAMPLE OF TTL CONNECTION	33
FIGURE 28: CONNECTION EXAMPLES	37



INTRODUCTION

The use of these devices has turned - IN EXCLUSIVE WAY - to specialized personnel.



Pins of Mini Module are not provided with any kind of ESD protection. They are connected directly to their respective pins of microcontroller. Mini Module is affected by electrostatic discharges. Personnel who handles Mini Modules is invited to take all necessary precautions to avoid possible damages caused by electrostatic discharges.

The purpose of this handbook is to give the necessary information to the cognizant and sure use of the products. They are the result of a continual and systematic elaboration of data and technical tests saved and validated from the manufacturer, related to the inside modes of certainty and quality of the information.

The reported data are destined- IN EXCLUSIVE WAY- to specialized users, that can interact with the devices in safety conditions for the persons, for the machine and for the environment, impersonating an elementary diagnostic of breakdowns and of malfunction conditions by performing simple functional verify operations , in the height respect of the actual safety and health norms.

The informations for the installation, the assemblage, the dismantlement, the handling, the adjustment, the reparation and the contingent accessories, devices etc. installation are destined - and then executable - always and in exclusive way from specialized warned and educated personnel, or directly from the TECHNICAL AUTHORIZED ASSISTANCE, in the height respect of the manufacturer recommendations and the actual safety and health norms.

The devices can't be used outside a box. The user must always insert the cards in a container that respect the actual safety normative. The protection of this container is not threshold to the only atmospheric agents, but specially to mechanic, electric, magnetic, etc. ones.

To be on good terms with the products, is necessary guarantee legibility and conservation of the manual, also for future references. In case of deterioration or more easily for technical updates, consult the AUTHORIZED TECHNICAL ASSISTANCE directly.

To prevent problems during card utilization, it is a good practice to read carefully all the informations of this manual. After this reading, the user can use the general index and the alphabetical index, respectly at the begining and at the end of the manual, to find information in a faster and more easy way.

CARD VERSION

The present handbook is reported to the **GMM AC Zero** card release **101102** and later. The validity of the bring informations is subordinate to the number of the card release.

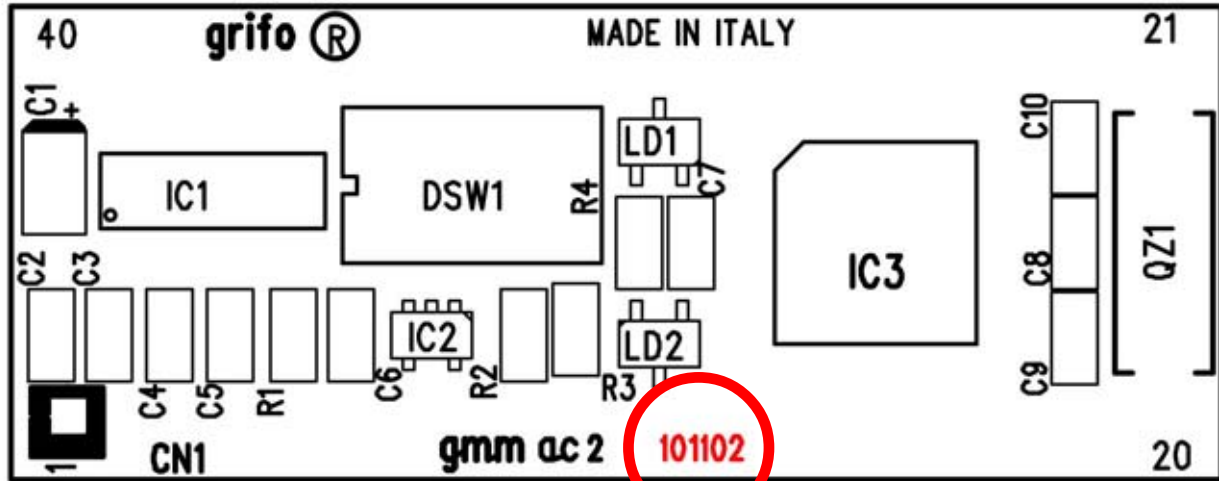

PRINTED CIRCUIT REVISION NUMBER

FIGURE 1: LOCATION OF REVISION NUMBER AND CARD NAME

NOTE ABOUT MINI MODULE NAME

Please note the Mini Module name, near the printed circuit revision number.

The name is **GMM AC2**.

GMM AC Zero is made starting from a **GMM AC2** printed circuit where a AT89C51CC03 is installed.

To distinguish **GMM AC2** and **GMM AC Zero** it is compulsive to refer the type of CPU installed, as reported here:

CPU installed:	AT89C51CC03	AT89C51AC2
Mini Module name	GMM AC Zero	GMM AC2

GENERAL INFORMATION

Mini Module **GMM AC Zero** (**grifo**® Mini Module AT89C51CC03), is based on microcontroller **Atmel T89c51CC03**, a powerful and complete system-on-a-chip provided with **CPU**, internal memory both for data and for code; **A/D converter**; **watch dog**; **interrupts**; **TTL digital I/O lines**, a **hardware serial line**, a **UART CAN**; **PWM**; **dedicated timer/counter with capture/compare capability**; etc..

Modules features some components that exploit microcontrollers's performance are already mounted, like the **reset controller**, that generates the reset signal and controls power supply level. Possible applications of **GMM AC Zero** Mini Modules are several.

We remark the employ as **smart intelligent nodes** with local functionalities as **PID algorithms** for controlling temperatures, motors, valves, etc..

Or as **decentralized systems** as robots; automation of production line machines, big factory automations; etc..

Finally, **teleacquisition** and **telecontrol** on medium and low distances or software emulation of **I²C BUS** line.

Intresting application is home automation performing tasks like lights turning ON/OFF; heating and cooling systems control; supervision of electric devices; security and acces control systems; etc..

Also **CAN applications** are possible, provided that Mini Module is supported by an external **CAN buffer**.

For example, native **CAN application**, that is **car automation**; connection on **CAN networks** with your proprietary protocol or with standard protocols (like **CANopen**, **DeviceNet**, **SDS**, **CAN Kingdom** etc.).

Last but not least, **didactics**: **GMM AC Zero** offers at very low cost the opportunity to learn how operates a family 8051 microcontroller and is typical applications.

Using **GMM TST 2** there is the possibility to try the several features of programming languages like **C**, **Pascal**, **Basic**, etc..

For learning, **grifo**® provides a wide range of programs, in source format to make several expericences.

Serial line, **LCD display** and **keyboard** of **GMM TST 2** allow to make a complete operator panel by which to study the way operation panels work and to examine the related problematics.

GMB HR168 is a useful complement for **GMM AC Zero**. In fact it allows to supply the Mini Module and to buffer the several I/O signals.

It also provides a serial communication line and a container that can be mounted on **Omega bars**.

Overall features of **GMM AC Zero** are:

- Standard container with **40 pins** male socket, **DIL**, 100 mils pitch, 600 mils width
- Very small dimension: 20.8 x 53.5 x 12.8 mm
- **4 layers PCB** to obtain best noisy resistance and best **EMI performance**
- Single power supply required **+5Vdc** (the current consumption may vary according to module connections)
- Availability of **Idle Mode** and **Power Down Mode**
- **Atmel AT89C51CC03** microcontroller (8051 code compatibile) with **14.74 Mhz** crystal
- Programmable machine speed at **12 or 6 clock cycle**; **64K FLASH** for code, **2K FLASH for boot loader**, **256 bytes IRAM** for data, **2K ERAM** for data, **2K EEPROM** for data
- **8 A/D converter channels** with **10 bits** resolution, **20 µsec** conversion time
- 14 interrupt sources with 4 priority levels

- **3 Timers Counters** up to 16 bits
- **5 PCA channels** up to 16 bits with PWM, watch dog, compare, capture, etc. functionality
- **34 digital I/O** lines available on connector
- Hardware serial line with Baud Rate up to 115200 Baud, at TTL level or buffered **RS 232** with protection against ± 15 kV discharges
- **UART CAN** compatible with 2.0 A and 2.0 B standards that can be connected to an external CAN buffer
- **Reset** and power supply control circuit
- Software **I²C BUS line**, available on connector
- 8 configuration dip switches
- 2 status LEDs managed by software
- Internal FLASH and EEPROM can be managed through **In System Programming**, or when the module is already mounted, by using the **serial** communication line
- **Software** for PC, that supports the ISP programming to download the generated code, inside on board FLASH
- Wide range of **development tools** as: C compiler (μ C/51, MCC51, HTC51, SYS51CW, DDS Micro C51); BASIC compiler (BASCOM 8051); PASCAL compiler (SYS51PW); etc.
- Long list of demo programs and use examples supplied under source form, duly remarked, for the available development tools.

DIGITAL I/O LINES

The Mini Module **GMM AC Zero** is provided with 34 digital I/O lines at TTL level, of the microprocessor Atmel AT89c51CC03, grouped in four 8 bit ports (P0, P1, P2 and P3) and in one 2 bit port (P4). Port bits are P0.0÷7, P1.0÷7, P2.0÷7, P3.0÷7 and P4.0÷1.

These lines are connected directly to 40 pins connectors with standard **grifo**[®] Mini Module pin out, allowing to be connected directly to several interface cards.

By software it is possible to define and acquire the function and the status of these lines, and also to match them to peripheral devices (like Timer Counter, Interrupt, etc.), simply programming some CPU internal registers.

For further information please refer to paragraph CONNECTIONS and PERIPHERAL DEVICES SOFTWARE DESCRIPTION.

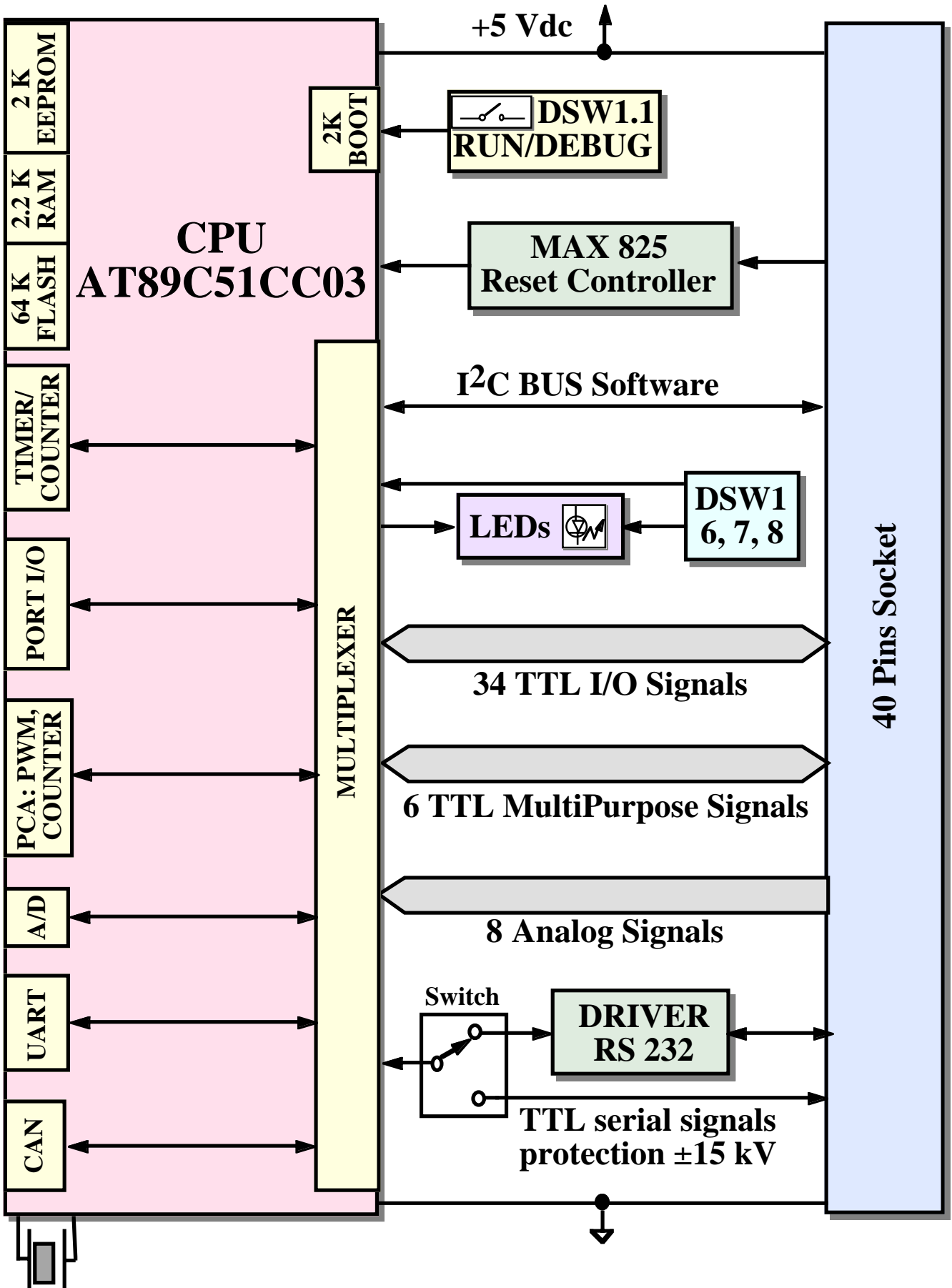

FIGURE 2: BLOCK DIAGRAM

I²C BUS LINES

Standard pin out of 40 pins grifo® Mini Module connector reserves two pins to I²C BUS interface, in special case of **GMM AC Zero** I²C BUS is emulated using lines P2.0 (SCL) and P2.1 (SDA). This interface allows to connect the devices featuring the same communication standard to expand local potentialities of Module.

There is wide range of software examples to manage most common devices with I²C BUS interface like A/D and D/A converters, display drivers, memories, temperature sensors, etc..

If you are interested at this, it can be useful for you to consider **K51-AVR** for which both technical manual featuring electric diagram and a complete set of examples are available.

A/D CONVERTER ANALOG SIGNALS

Mini Module **GMM AC Zero** provides 8 analog inputs of Atmel AT89c51CC03 internal A/D converter, that is signals AN0÷AN7 multiplexed on signals P1.0÷P1.7.

Main features of this section are: resolution 10 bit; 8 analog inputs in the range 0÷3 Vdc; conversion time on a single channel 20 µsec; very easy software management; end of conversion interrupt.

A/D conversions are performed using the successive approximations technique and are made through opportune manipulation of specific microcontroller internal registers.

To easy A/D converter management, some software packages are provided with utility procedures that manage all details of this section.

For further information please refer to data sheet of appendix A of this manual or paragraph "CONNECTIONS".

MEMORY DEVICES

The card is provided of 70.25K of memory divided with a maximum of **64K** Bytes FLASH EPROM; **2K** Bytes FLASH EPROM for boot loader; **256** Bytes of internal IRAM; **2K** Bytes of auxiliary external ERAM and **2K** Bytes of internal EEPROM.

Thanks to on board EEPROM or backed SRAM there is the possibility to keep data also when power supply is failed; in this way the card is always able to maintain parameters, logged data, system status and configuration, etc. in each working conditions.

Whenever the amount of memory for data is not sufficient (i.e. for data logging systems), it is always possible to connect external memory devices (with SRAM, EEPROM, FLASH technologies) through the comfortable and efficient I²C BUS interface of the card (please see previous paragraph).

The addressing of memory devices is controlled by microcontroller as described in the component data sheet or in APPENDIX A of this manual.

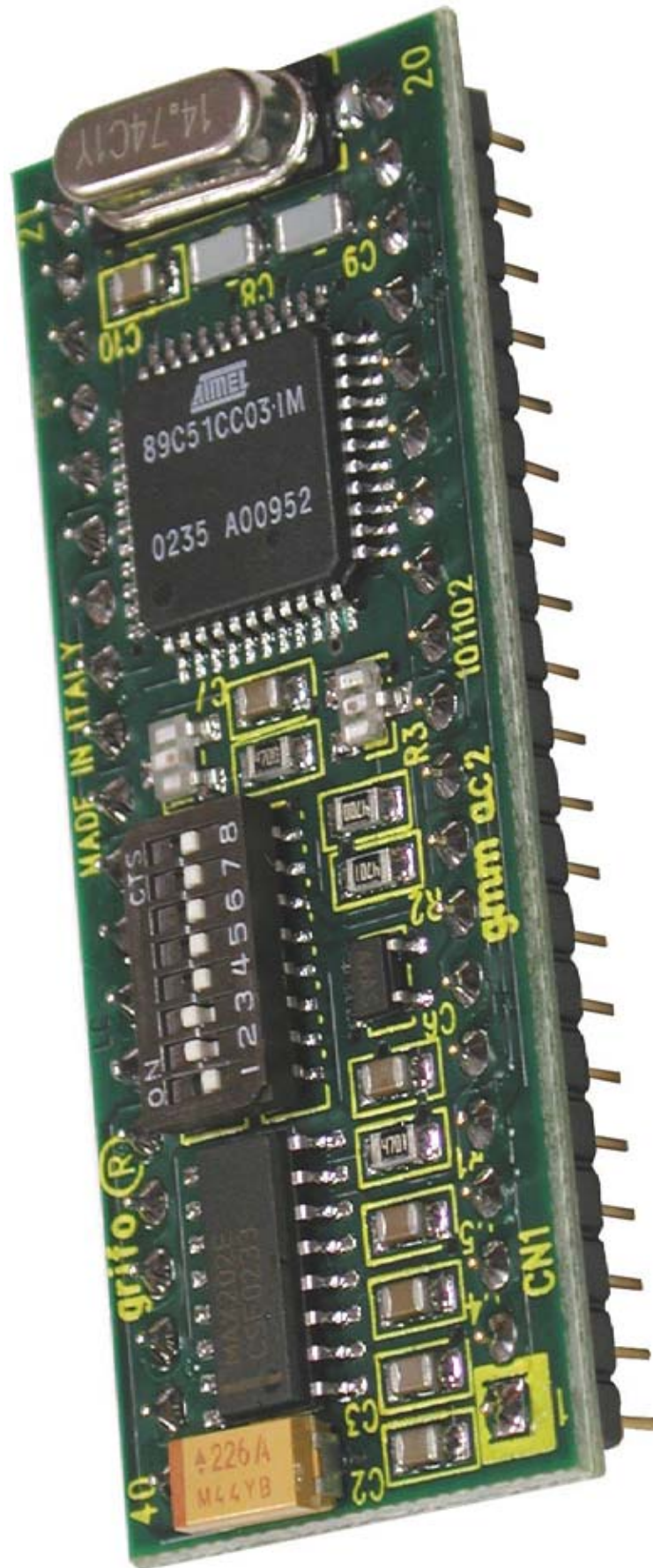

FIGURE 3: MODULE GMM AC ZERO

WATCH DOG

Microcontroller AT89c51CC03 is provided with an internal hardware watch dog capable to reset the CPU if the user program cannot retrigger it in less than the selected intervent time.

Intervent time range is rather wide, it is from about 9 ms to 1 second.

For further information refer to microcontroller data sheet or to appendix A of this manual.

BOARD CONFIGURATION

GMM AC Zero Mini Module is provided with an on board dip switch whose purpose is to set up several electric parameters of module itself and logical parameters of application program.

Dip 1 is used at power on or after a reset to determine which working modality, RUN or DEBUG, to use, that is, respectively, whether the micro has to run the user application program or the FLASH boot loader

Dip from 2 to 5 switch between RS 232 or TTL serial signals.

The software can acquire dips 6, 7 and 8 without having to access the I/O signals and manage different conditions with an unique program (like different languages, program parameter, operating modalities, etc.).

In addition, the board is also provided with two signalation LEDs, software manageable, that can be used to signal in visual ways board status and configurations, as described in the specific paragraphs.

All the configuration resources described are completely software manageable simply programming specific registers allocated in the I/O space by the control logic.

For further information refer to paragraphs "DIP SWITCH" and "CONFIGURATION INPUTS".

CLOCK

On **GMM AC Zero** module there is one clock circuitry that generates the clock signal for the microcontroller.

Such circuitry is based on a quartz that generates a 14.7456 MHz frequency.

To improve speed performance, **GMM AC Zero** may also set the machine clock cycle duration to 12 or 6 clock cycles (X2 mode).

In X2 mode code execution is two times faster than in a classic 8051 architecture.

SERIAL COMMUNICATION

On **GMM AC Zero** it is always available an hardware serial line that is completely software configurable for physical protocol (baud rate, stop bits number, lenght of character, etc) by simply programming some microprocessor registers.

For firther information refer to the manufacturer documentation or in the appendix A of this manual. The serial line is connected to CN1 connector at TTL or RS 232 level, thanks to some on board dip switches configuration, so when the card must be connected in a network or at long distance or with other systems that use different electric protocol, the user must provide external drivers (RS 232, RS 422, RS 485, Current loop, etc.).

Please remember that on CN1 connector in addition to standard receive and transmit signals are also available other I/O signals that can be driven by software; these signals can be used to define the RS 485 line direction, to enable the RS 422 transmit drive or to generate an RS 232 handshake. For example the **MSI01** module that converts a TTL serial line in any other electric standards in a pratical and inexpensive way can be used.

Please read "SERIAL COMMUNICATION SELECTION" paragraph of this manual or contact directly **grifo®** technician for further explanation or any other necessary information.

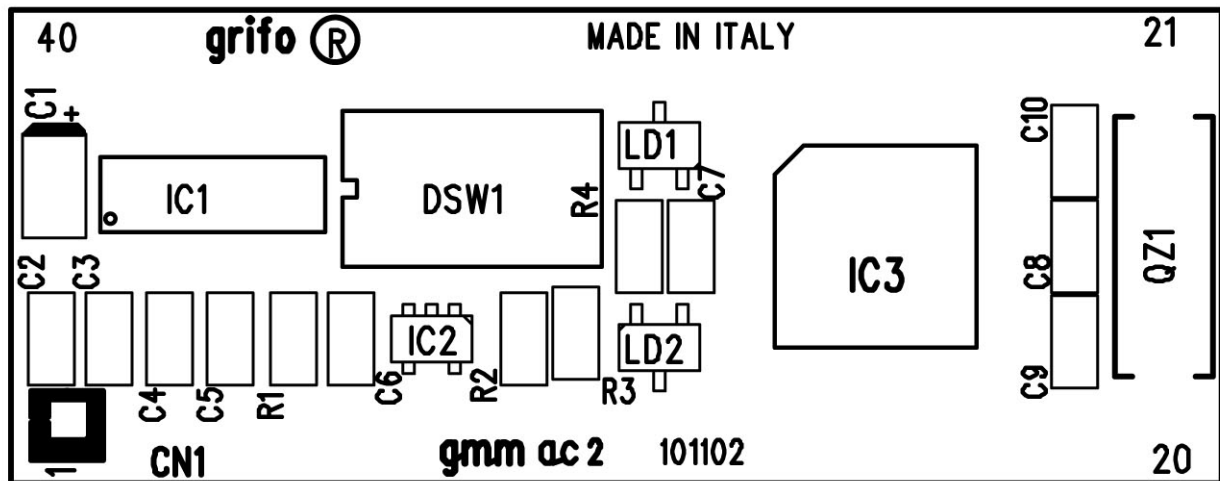

FIGURE 4: COMPONENTS MAP

TECHNICAL FEATURES

GENERAL FEATURES

Devices:	34 digital TTL I/O signals	
	8 A/D converter analog inputs	
	5 lines PCA section	
	1 Watch Dog section	
	3 Programmable Timer/Counter	
	14 interrupt sources and 4 interrupt levels	
	1 reset generator	
	1 RS 232 serial line	
	1 UART CAN	
	1 eight pins dip switch	
	2 status LEDs	
Memories:	64K Byte FLASH	user program
	2K Byte FLASH	boot loader
	2K Byte EEPROM	user data
	2K Byte ERAM	user data
	256 Bytes IRAM	user data
CPU:	Atmel AT89c51CC03	
Clock frequency:	14.7465 MHz	
A/D resolution:	10 bit	
A/D conversion time:	20 μ sec	
Power on time:	typical 280 msec	
Watch Dog intervent time:	programmable from about 9 msec to 1 sec	

PHYSICAL FEATURES

Size:	20.8 x 53.5 x 12.8 mm	
Weight:	9.1 g	
Connectors:	40 pins male socket DIL	
Temperature range:	0÷50 °C	
Relative humidity:	20%÷90%	(without condense)

ELECTRIC FEATURES

Power supply voltage:	+5 Vdc \pm 5%	
Current consumption:	21 mA	(power down mode)
	26 mA	(normal working mode)
Analog inputs voltage range:	0 \div 3 Vdc	
Analog inputs impedance:	high	
Power failure threshold:	typical 4.56 Vdc	

**FIGURE 5: TOP VIEW OF MINI MODULE GMM AC ZERO**

INSTALLATION

In this chapter there are the information for a right installation and correct use of **GMM AC Zero** card.

In detail there are the locations and functions of each connector, of the user settable dip switches, LEDs, and so on.

VISUAL SIGNALATIONS

GMM AC Zero features the LEDs described in the following table:

LED	COLOUR	PURPOSE
LD1	Green	If ON, indicates that signal P2.6 (pin 17 of microcontroller) is at low level (zero volt) or that DSW1.7 is ON.
LD2	Red	If ON, indicates that signal P2.7 (pin 16 of microcontroller) is at low level (zero volt) or that DSW1.6 is ON.

FIGURE 6: LEDs TABLE

The main function of LEDs is to inform the user about card status, with a simple visual indication and in addition to this, LEDs make easier the debug and test operations of the complete system. To recognize the LEDs location on the card, please refer to figure 9, while for further information please refer to paragraph **ACTIVITY LED**.

CONNECTIONS

The **GMM AC Zero** module has 1 connector that can be linkeded to other devices or directly to the field, according to system requirements.

In this paragraph there are connector pin out, a short signals description (including the signals direction) and connectors location (see figure 9) that simplify and speed the installation phase.

Some additional figures shows the pins functionalities and some of the most frequently used connections.

CN1 - EXTERNAL MINI MODULE SIGNALS CONNECTOR

CN1 is a 40 pins, male, dual in line, socket connector with 100 mils pitch and 600 mils width. On CN1 are available all the interfacement signals of the Mini Module as the power supply, the I/O lines, the asynchronous communication lines, the on board peripheral devices signals, the operating mode selection lines, etc.

Some pins of this connector have multiple purposes, in fact they can be multiplexed by programming some software registers with several CPU internal devices and the following figure lists all these possible functionalities.

So the signals available on CN1 have different types as described in the following CONNECTOR SIGNALS INTERFACEMENT paragraph and they follow grifo® Mini Module standard pin out. To avoid problems in pin counting and numbers the figure 7 shows the signals directly on the top view of the GMM AC Zero; moreover the serigraph reports the pins number on the four corner of the card both on bottom (solder) and top (component) side.

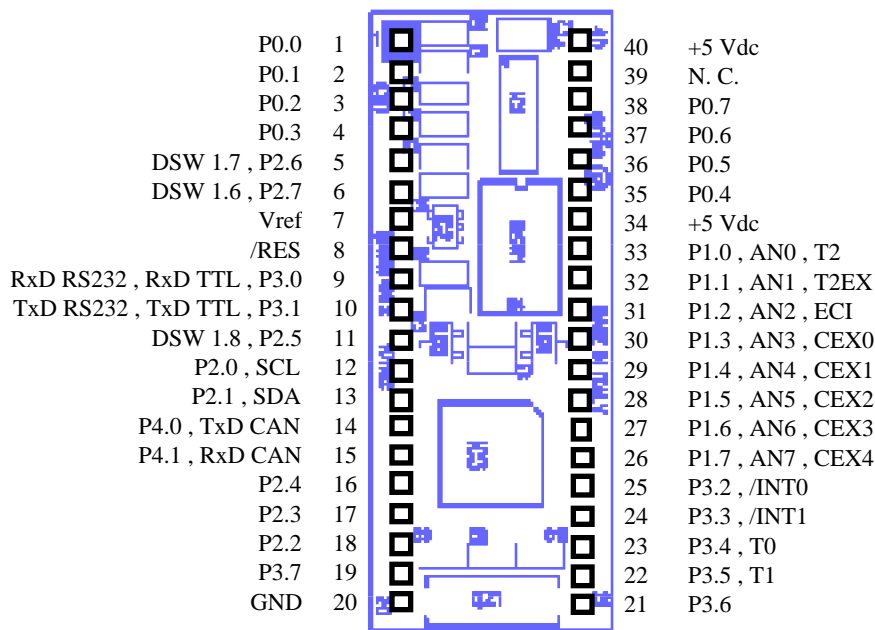

FIGURE 7: SOCKET AND MINI MODULE SIGNALS

Signals description:

- +5 Vdc** = I - Power supply +5 Vdc
- GND** = - Ground
- RxD RS232 , TTL** = I - Receive Data in RS 232 or TTL
- TxD RS232 , TTL** = O - Transmit Data in RS 232 or TTL
- /INTn** = I - CPU internal interrupt (/INT0 and /INT1)
- Tn** = I - External inputs for timer 0, 1 and 2 count
- T2EX** = I - Trigger inputs for timer 2
- /RES** = I/O - CPU reset signal
- SCL, SDA** = I/O - Clock and Data signals of software I²C BUS
- Px.0÷7** = I/O - CPU TTL I/O digital Port x signals
- AN0÷7** = I - Analog inputs
- CEX.0÷4** = I/O - Digital inputs or PWM outputs of PCA 0÷4 (multiplexed)
- ECI** = I - External clock digital input of PCA 0÷4 (multiplexed)
- Vref** = I - A/D converter reference voltage

CONNECTOR SIGNALS INTERFACEMENT

To prevent possible connecting problems between **GMM AC Zero** and the external systems, the user has to read carefully the previous paragraph information and he must follow these instructions:

- For RS 232 signals the user must follow the standard specifications of this protocol, defined by CCITT normative;
- All TTL signals must follow the rules of this electric standard. The connected digital signals must be always referred to card ground (GND) and then the 0V level corresponds to logic status 0, while the 5V level corresponds to logic status 1. The connection of these lines to devices of the controlled system (encoders, switches, proximity, electric valves, power relays, etc.) must be performed through proper power interfaces; it is preferable to adopt opto coupled interfaces that ensure an electric insulation between Mini Module electronic and external noisy, typically generated by power electronic.
- The inputs for analog section must be connected to low impedance signals in the range from 0 to 3.0 V, to assure greater stability and precision.
- PWM signals generated by Timer Counter and CCU sections are TTL type so they must be buffered to interface the power circuitry. Typical interfaces can be current driver (if PWM signal is still required) or an integrator circuit if analog voltage is required.
- Also I²C BUS signals are at TTL level, as defined by the same standards; for completeness it is remarked that in a network with several devices and rather long it is better to study the connection lay out and to set properly the output stage, the best operational modes and the programmable bit rate: all these conditions allow communications in any condition.

DIP SWITCH

An 8 pins dip switch is installed on **GMM AC Zero** Mini Module.

It allows to perform selection regarding the module's working way.

Figure 8 shows a list of switches connection and purpose, in the table * (asterisk) means default connection, that is the configuration of the board after test in our laboratories.

To locate the dip switch, please refer to figure 9.

SWITCH	POSITION	PURPOSE	DEF.
1	ON	Connects signal /PSEN (pin 32 of microcontroller) to the ground (zero volt). If Mini Module is turned on or reset in this condition, DEBUG mode is enabled and Boot Loader runs.	*
	OFF	Does not connect signal /PSEN (pin 32 of microcontroller). If Mini Module is turned on or reset in this condition, RUN mode is enabled and user program stored in microcontroller FLASH memory runs.	
2	ON	Connects signal TxD RS 232 , TxD TTL , P3.1 of CN1 to serial driver. DSW1.4 must be OFF to avoid conflicts. Used in conjunction with switch DSW1.4.	*
	OFF	Does not connect signal TxD RS 232 , TxD TTL , P3.1 to serial driver, allowing direct connection to CPU.	
3	ON	Connects signal RxD RS 232 , RxD TTL , P3.0 of CN1 to serial driver. DSW1.5 must be OFF to avoid conflicts. Used in conjunction with switch DSW1.5.	*
	OFF	Does not connect signal RxD RS 232 , RxD TTL , P3.0 to serial driver, allowing direct connection to CPU.	
4	ON	Connects signal TxD RS 232 , TxD TTL , P3.1 of CN1 directly to CPU. DSW1.2 must be OFF to avoid conflicts. Used in conjunction with switch DSW1.2.	*
	OFF	Does not connect signal TxD RS 232 , TxD TTL , P3.1 directly to CPU, allowing connection to serial driver.	
5	ON	Connects signal RxD RS 232 , RxD TTL , P3.0 of CN1 directly to CPU. DSW1.3 must be OFF to avoid conflicts. Used in conjunction with switch DSW1.3.	*
	OFF	Does not connect signal RxD RS 232 , RxD TTL , P3.0 directly to CPU, allowing connection to serial driver.	
6	ON	Connects signal P2.7 to logic level 0, allowing to acquire it as user input and turning ON LED LD2.	*
	OFF	Does not connect signal P2.7, so the user can drive LD2.	
7	ON	Connects signal P2.6 to logic level 0, allowing to acquire it as user input and turning ON LED LD1.	*
	OFF	Does not connect signal P2.6, so the user can drive LD1.	
8	ON	Connects signal P2.5 to logic level 0, allowing to acquire it as user input.	*
	OFF	Does not connect signal P2.5.	

FIGURE 8: DIP SWITCH

INTERRUPTS MANAGEMENT

One of the most important **GMM AC Zero** features is the powerful interrupts management. Here is a short description of how the board's hardware interrupt signals can be managed; a more complete description of the hardware interrupts can be found in the microprocessor data sheets or in appendix A of this manual.

- Pin 25 of CN1 -> Generates /INT0 = P3.2 on the CPU.
- Pin 24 of CN1 -> Generates /INT1 = P3.3 on the CPU.
- CPU inside devices -> Can generate an internal interrupt. Possible sources of internal interrupt events are: timer 0÷2, PCA, UART, CAN controller, A/D converter, CAN timer.

The microprocessor features a programmable priority structure that manages the case of contemporary interrupts.

The addresses of the interrupt response subroutines can be software programmed by the user placing them on the proper code areas while the interrupts priority level and activation are software programmable through internal CPU registers. So the user program has always the possibility to react promptly to every external event, deciding also the priority of interrupts.

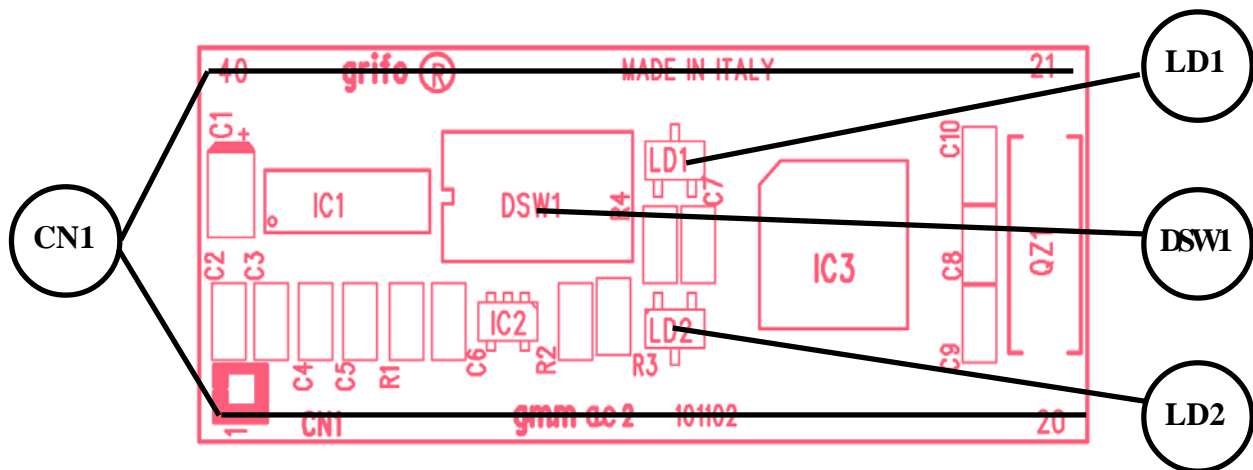

FIGURE 9: LEDs, DIP SWITCH, ETC. LOCATION



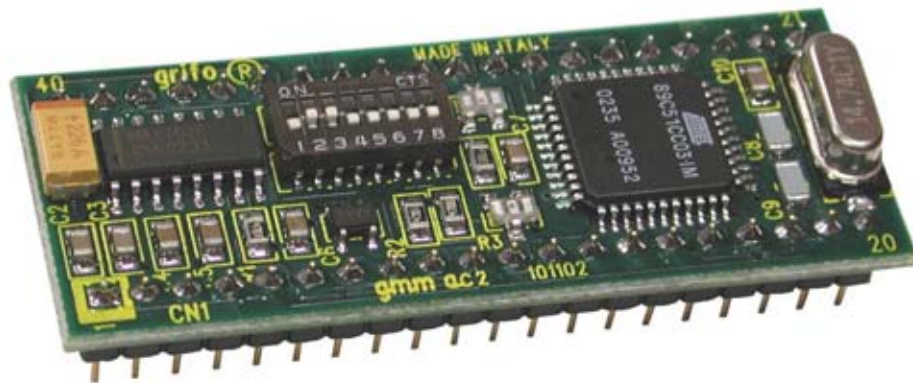

FIGURE 10: GMB HR168 AND GMM AC ZERO

SUPPORT CARDS

GMM AC Zero Mini Module can be used as a macro components for some support cards either developed by the user or directly chosen from the **grifo**[®] boards.

In the following paragraphs are reported the suggested configuration of the most interesting support cards.

USE WITH GMB HR168 MODULE

Amongst **grifo**[®] cards, **GMB HR168** module is the one designed specifically to provide 16 optocoupled inputs; relay outputs and in addition to the comfortable cabling by quick release connectors and the possibility to install on omega rails.

It can be also ordered with an optional Real Time Clock (code option **.RTC**) backed up through a Lithium battery, featuring 240 Bytes of SRAM and capable to manage hour, minutes, seconds, day, month and year.

The complete description of the product is available in the relative data sheet and technical manual while in this paragraph are listed the advantages obtained by using this pair of cards.

GMB HR168 allows easily to:

- to supply the Mini Module through on board power supply;
- to have sixteen TTL I/O signals of microprocessor ports optocoupled NPN and PNP at the same time and visualized through LEDs (green for the first byte and yellow for the second byte); I/O signals are multiplexed with timer inputs, so developed functions like counters are immediatly available;
- to have eight TTL I/O signals of microprocessor ports on bufferd relays driving and visualized through red LEDs;
- to connect on **I²C BUS** and +5 Vdc power supply on a dedicated connector;
- to connect immediatly communication serial line through a comfortable 8 pins standard AMP MODU II 8 pins connector;
- to buffer easily TTL UART signals from microprocessor in RS 422, RS 485 or current loop;
- to connect PWM signal through a comfortable standard AMP connector;
- to have an optional Real Time Clock (code **.RTC**) installed on board featuring date and time, periodic interrupt generation, 240 Bytes SRAM and Lithium battery backup;



FIGURE 11: GMM TST EXPERIMENTAL CARD WITH GMM AC ZERO INSTALLED

USE WITH GMM TST 2 BOARD

Amongst **grifo**[®] cards, **GMM TST 2** is the one designed specifically to be the prototyping board supporting **GMM xxx** Mini Modules featuring 28 or 40 pins.

Electric diagram of **GMM TST 2** can be found on appendix B.

GMM TST 2 allows easily:

- to supply the Mini Module through on board power supply
- to have I/O port and A/D converter signals on a comfortable low profile connector compliant to standard **I/O ABACO**[®]
- to connect immediately RS 232 signals through a comfortable D9 female type connector
- to set and visualize the status of 2 microcontroller I/O signals through coloured push buttons and LEDs excludible by jumpers
- to generate sound feedback using the autoscillating on board buzzer
- to develop quickly and comfortably user interface application taking advantage of on-board LCD backlit 20x2 display and the 4x4 matrix keyboard

Following configuration allows to use the match **GMM TST 2** + **GMM AC Zero** in their basic version and in RS 232:

Configuration GMM AC Zero

DSW1.1	=	OFF
DSW1.2	=	ON
DSW1.3	=	ON
DSW1.4	=	OFF
DSW1.5	=	OFF
DSW1.6	=	OFF
DSW1.7	=	OFF
DSW1.8	=	OFF

Configuration GMM TST 2

J1	=	1-2
J1	=	2-3
J2	=	2-3
J3	=	1-2
J4	=	2-3
J5	=	2-3
J6	=	2-3
J7	=	2-3

The serial connection cable with development P.C. is the CCR 9+9 (or in other words an extension cable provided of D9 Female and D9 Male connectors).

HOW TO START

Across this chapter we presume that you have a **GMM TST 2** where to install **GMM AC Zero**. One of the most important features of **GMM AC Zero** Mini Module is the possibility to program the microprocessor AT89c51CC03 internal memory with in system programming (ISP) through serial interface, both UART and CAN controller, according to the model installed.

A) SERIAL CONNECTION BETWEEN GMM AC Zero AND PC:

A1) To make the serial connection between **GMM AC Zero** and a PC, the stricture described on figure 12 should be built.

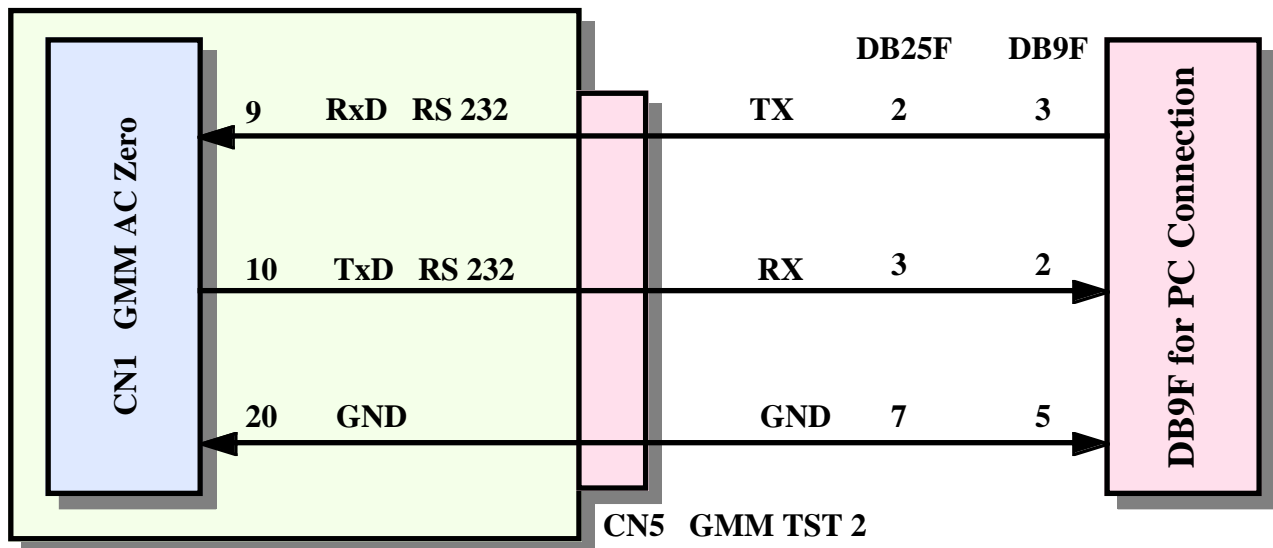

FIGURE 12: RS 232 SERIAL CONNECTION BETWEEN A GMM AC ZERO AND A PC

A2) Keep ready for running a terminal emulator on PC, configure it to use the serial port where Mini Module is connected with 19200 baud, 8 data bits, 1 stop bit, no parity. If you are using BASCOM 8051, you simply can open the terminal emulator in its IDE.

A3) Set Mini Module in DEBUG mode, that is DSW1.1 ON.

A4) Supply **GMM TST 2**. Find the demo program of **GMM AC Zero** on **grifo®** CD, the file is called "pr_ac0.hex" and can be found from the starting following the path: English | Examples Tables | Mini Block and Mini Modules programs | GMM AC0.

B) FLASH REPROGRAMMING:

- B1) Find and save to a comfortable position on your hard drive the file "pr_ac0.hex".
- B2) On **grifo**® CD it is also available the utility program FLIP. that manages the ISP programming of microcontroller memories on board of **GMM AC Zero** through the simple serial connection seen at point A; find it and install it on a comfortable position on your hard drive. It is suggested to use version 2.2.0 or greater, the latest verion is available on Atmel website: www.atmel.com.
- B3) Put switch 1 of DSW1.1 of **GMM AC Zero** in position ON, to set DEBUG mode.
- B4) Close the terminal emulator, if open.
- B5) Turn off and then turn on again **GMM TST 2**.
- B6) Run ISP programming software installed at step B2.
- B7) Select the CPU to program, that is AT89c51CC03, by pressing the first button on top left, picking the name in the window that appears and pressing OK.

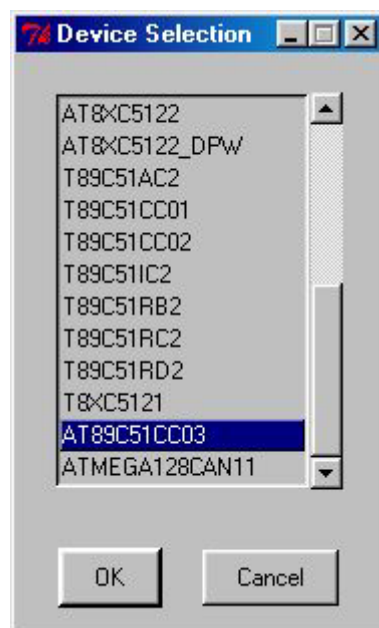

FIGURE 13: FLIP SETTINGS WINDOW (1 OF 3)



PROGRAMMI PER MINI MODULI E MINI BLOCK

TIPO DI SCHEDA	GET	ASM	Ladder	Abaco® Link BUS	BASIC CBZ80	BASIC BASCOM 8051	BASIC BASCOM AVR	PIC BASIC	BASIC VARI	MCS8® Basic 52	C	PASCAL	TIPO DI CPU / BLOCK
VARI	-	-	-	-	-	•	-	-	-	-	-	-	-
CAN GM0	•	-	-	-	-	•	-	-	-	-	•	-	Atmel T89C51cc03 - 8051 Code
CAN GM1	•	-	-	-	-	•	-	-	-	-	•	-	Atmel T89C51cc01 - 8051 Code
CAN GM2	•	-	-	-	-	•	-	-	-	-	•	-	Atmel T89C51cc02 - 8051 Code
GMM 5115	•	-	-	-	-	•	-	-	-	-	•	-	Atmel T89C5115 - 8051 Code
GMM 876	•	-	-	-	-	-	-	•	-	-	-	-	Microchip PIC16F876A - PIC 14 Code
GMM 932	•	-	-	-	-	•	-	-	-	-	-	-	PHILIPS P89LPC932 - 8051 Code
GMM AC2	•	-	-	-	-	•	-	-	-	-	•	-	Atmel T89C51AC2 - 8051 Code
GMM AM08	•	-	-	-	-	-	•	-	-	-	-	-	Atmel ATmega08 - AVR Code
GMM AM32	•	-	-	-	-	-	•	-	-	-	-	-	Atmel ATmega32 - AVR Code
GMB HR84	•	-	-	-	-	•	•	•	-	-	•	-	Mini Block 8 input opto 4 output relè
GMB HR168	•	-	-	-	-	•	-	-	-	-	•	-	Mini Block 16 input opto 8 output relè



FIGURE 14: EXAMPLES TABLE



B8) Select communication speed with Mini Module by pressing the second button on the top left, picking RS 232 the 115200 and the serial port used to connect the PC to Mini Module then press OK:

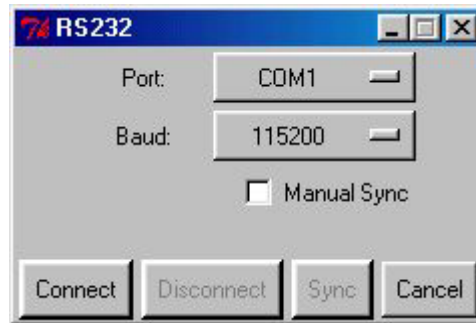

FIGURE 15: FLIP SETTINGS WINDOWS (2 OF 3)

If a window with the message "Timeout Error" should appear after 20 seconds, try to decrease the baud rate; or to repeat point from B1 to here; or verify the correct connection between PC and Mini Module repeating the points from A1 to A4.

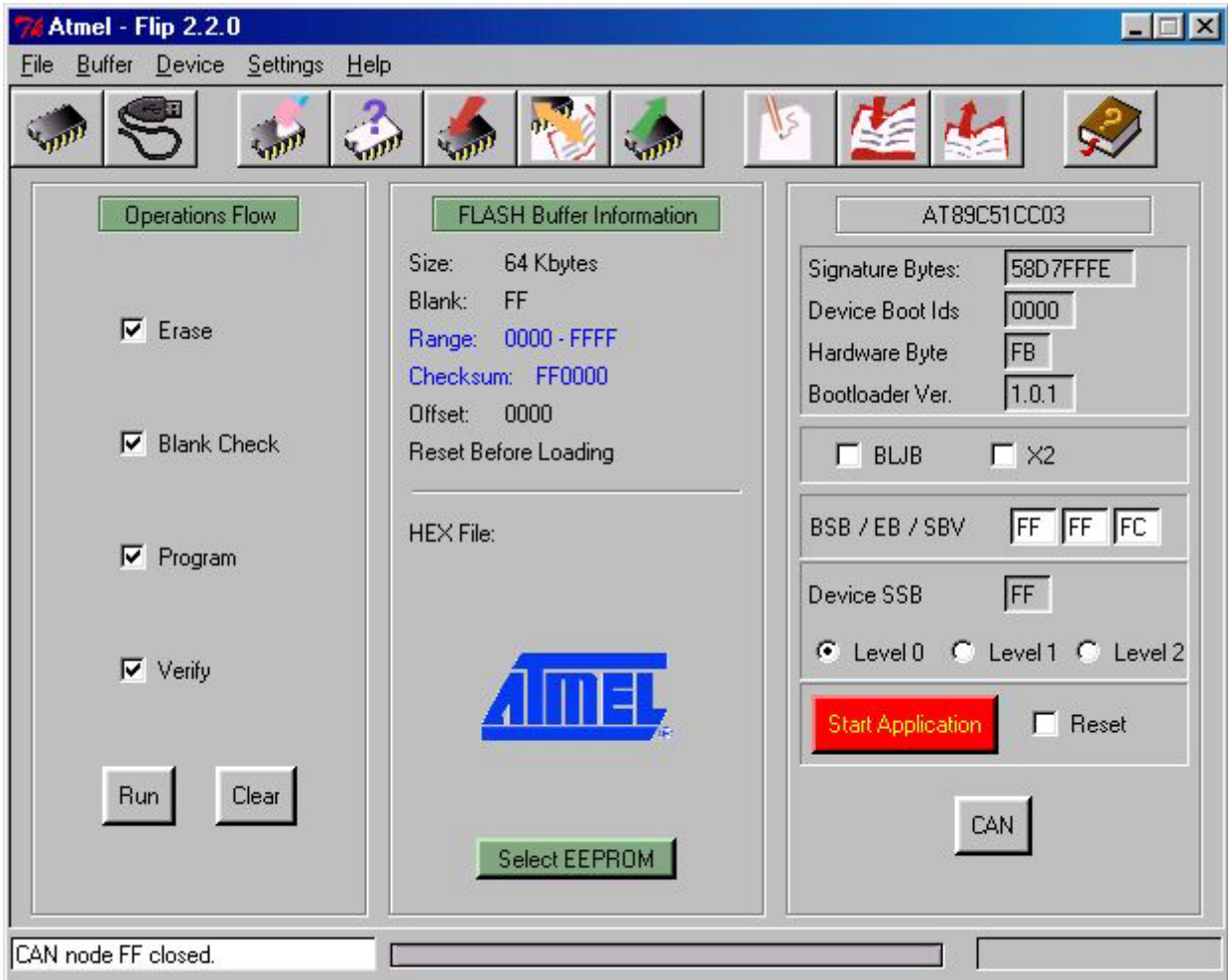

FIGURE 16: FLIP SETTINGS WINDOWS (3 OF 3)

- B9) Make sure that text boxes in the frame AT89C51CC03 fill with text, like in figure 16.
- B10) Load the file to write in FLASH (that is pr_ac0.hex) pressing the third button on top right and selecting the file using the dialog box. In the frame "FLASH Buffer Information" several information about the file just loaded appear; in detail the box "HEX File:" must report the file name.
- B11) Check all the check boxes in the frame "Operations Flow".
- B12) Press button "Run" in the same frame.
- B13) The status bar on the bottom reports operation progress, text box in the bottom left reports operation status, check boxes become red and then green when the respective operation is successfully completed. Wait for "Verify" check box to become red.
- B14) Close **FLIP**.
- B15) Start the terminal emulator configured like in point A2.
- B16) Set RUN mode, that is DSW1.1 OFF.
- B17) Reset or Power off and then on the card; the terminal emulation window now must show the demo program start screen, like in point A4.

C) *GENERATING DEMO EXECUTABLE CODE:*

- C1) Install on the hard disk of the development P.C. the software environment selected to develop the application program. There are many different software tools that satisfy any customer's requirements but here we remind only the most diffused as the BASCOM 8051, μ C/51, LADDER WORK, etc.
- C2) On **grifo**® CD in addition to file with the executable code of the demo program, described at point A4, there are also the source file of the same. These have an extension that identifies the used software development tools (for example pr_ac0.bas for BASCOM 8051, pr_ac0.c for μ C/51 or pr_ac0.pjn for LADDER WORK) and they are properly organized inside demo programs tables available on CD, together with possible definition file (pr_ac0.mak and canary.h for μ C/51, 89c51CC03.dat for BASCOM 8051, etc.). Once these files have been located they must be copied in a comfortable folder on the hard disk of development P.C.
- C3) Compile the source file by using the selected software tools: the file pr_ac0.hex must be obtained equal to those available on **grifo**® CD and already used at steps B. This operation is very different according to the programming environment selected, so here follow the details:

I) *Ricompilation using BASCOM 8051.*

Ia) When in BASCOM IDE, load the program source with menu File | Open:

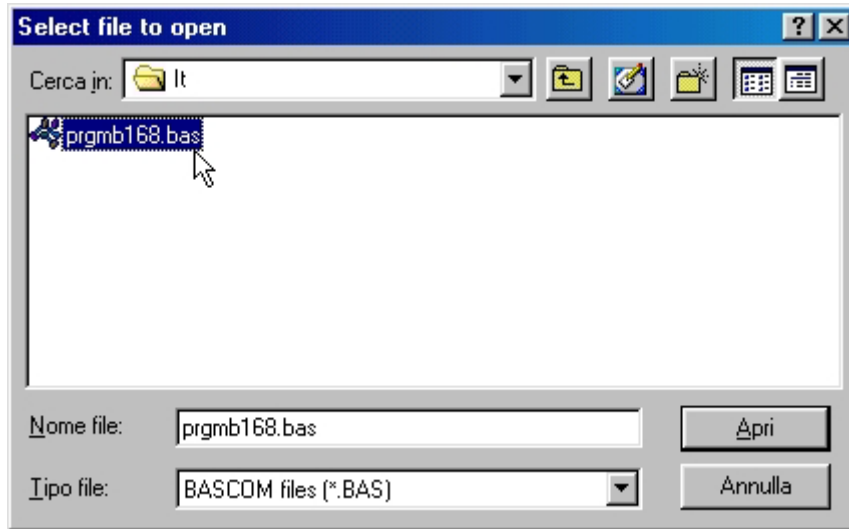

FIGURE 17: LOADING A SOURCE FILE WITH BASCOM 8051

Ib) From menu Options | Compiler | Misc set the value of Byte End to A0, as suggested also in the source code, and press OK:

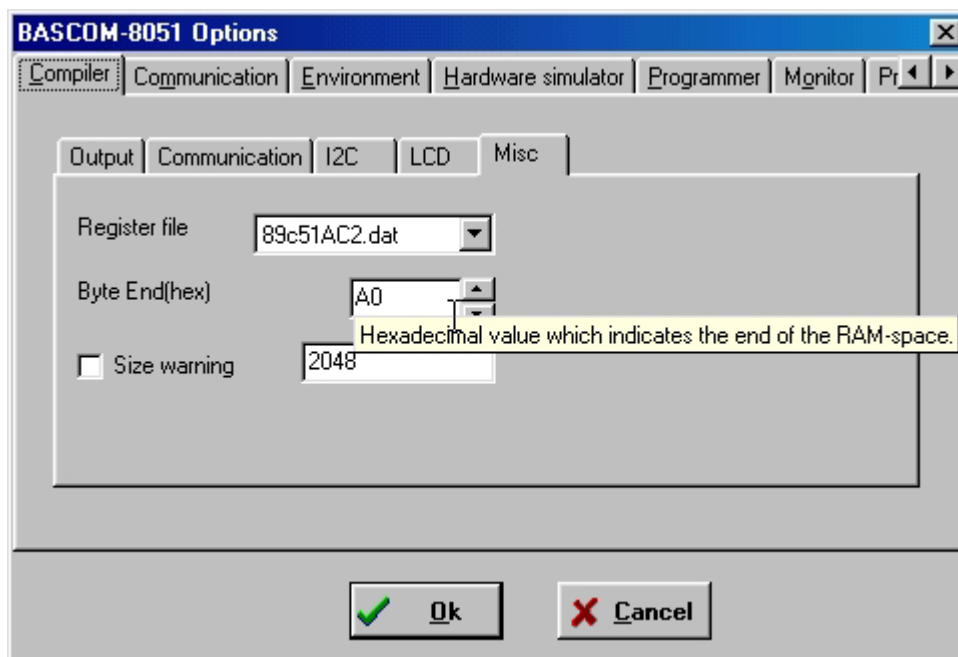

FIGURE 18: CONFIGURATION OF COMPILER BASCOM 8051

Ic) Compile the source file by pressing the button with the icon of an integrated circuit. Presence of file 89c51CC03.DAT in BASCOM installation folder is required in order to compile correctly:

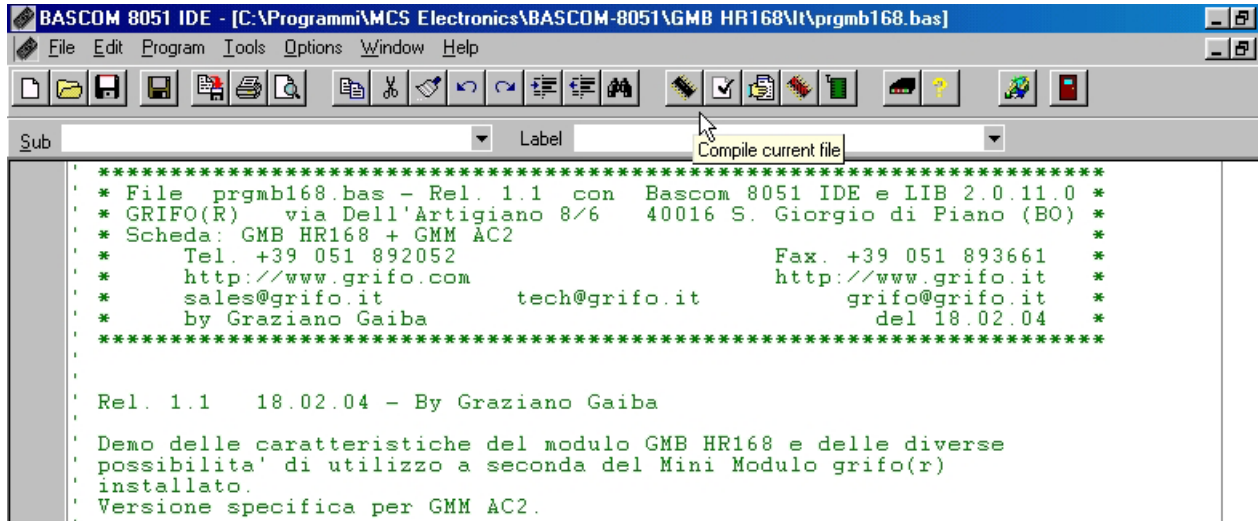

FIGURE 19: COMPILATION WITH BASCOM 8051

II) *Ricompilazione with μ C/51.*

Iia) After opening standard editor uedit.exe, load the source file pressing the fifth button from the left, the presence of file canary.h in the same folder of file pr_ac0.c is required for a correct compilation:

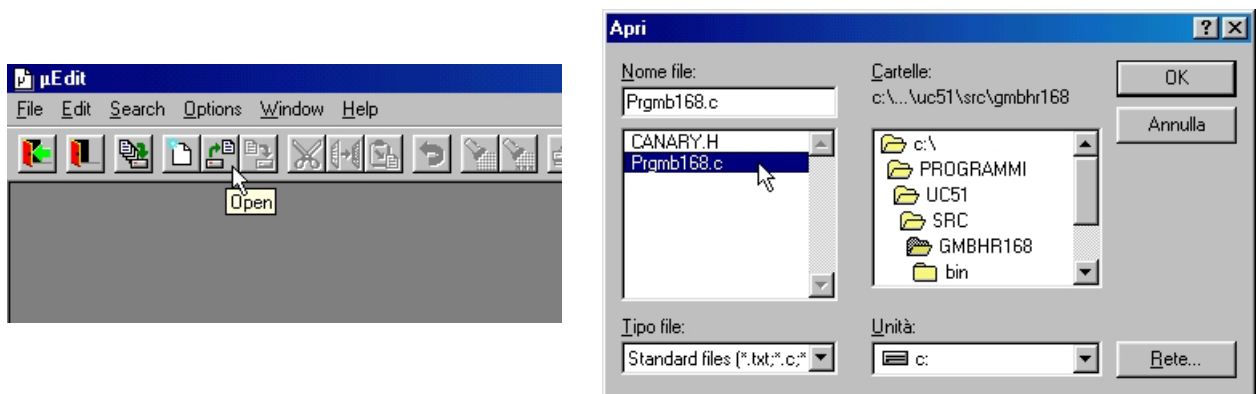

FIGURE 20: LOADING SOURCE FILE WITH μ C/51

Iib) Open also MakeFile editor, that is program umshell.exe, and load file pr_ac0.mak with the menu File | Load:

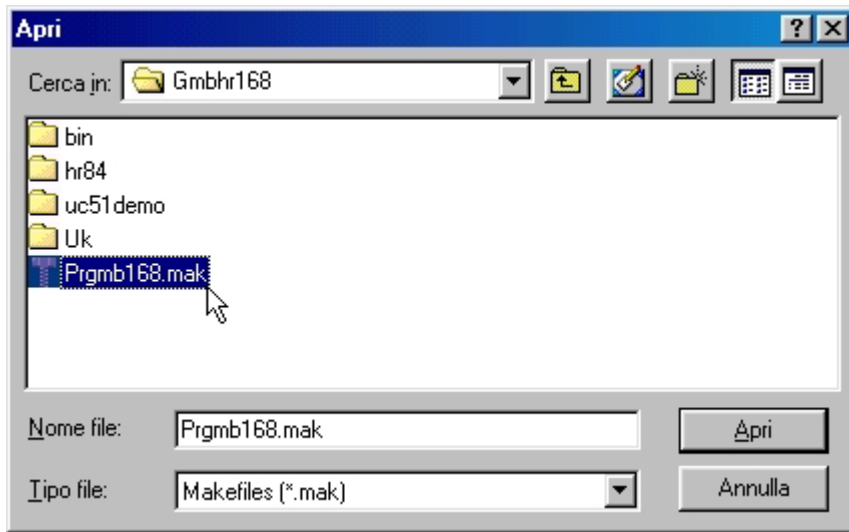

FIGURE 21: LOADING MAKEFILE (COMPILING CONFIGURATION) WITH μ C/51

IIc) Compile the source file pressing the first button from the right:

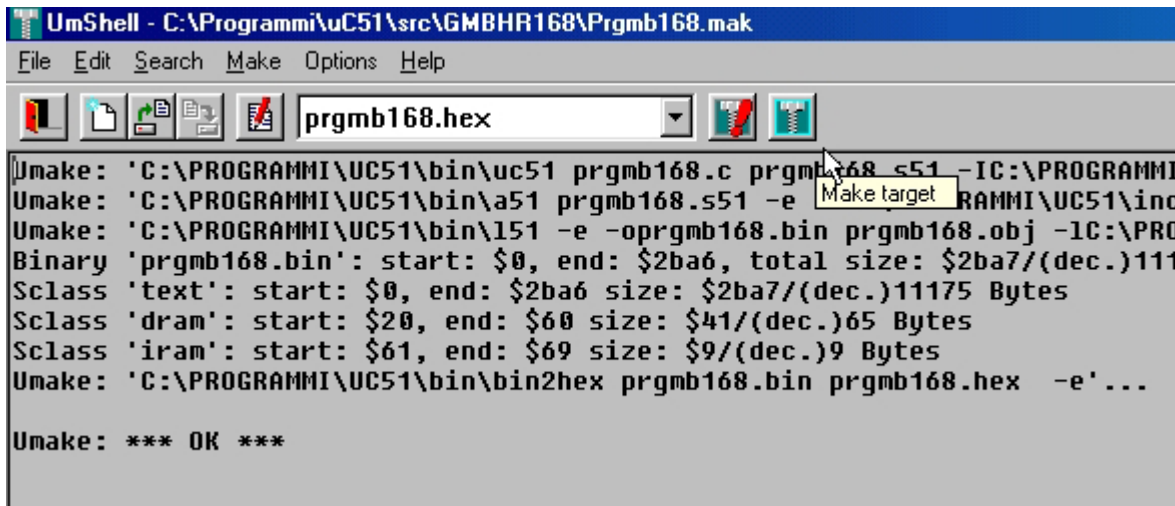

FIGURE 22: COMPILATION USING μ C/51

III) *Ricompile using LADDER WORK.*

IIIa) After opening IDE of LADDER WORK, open the schematic file called pr_ac0.pjn with menu File | Open:

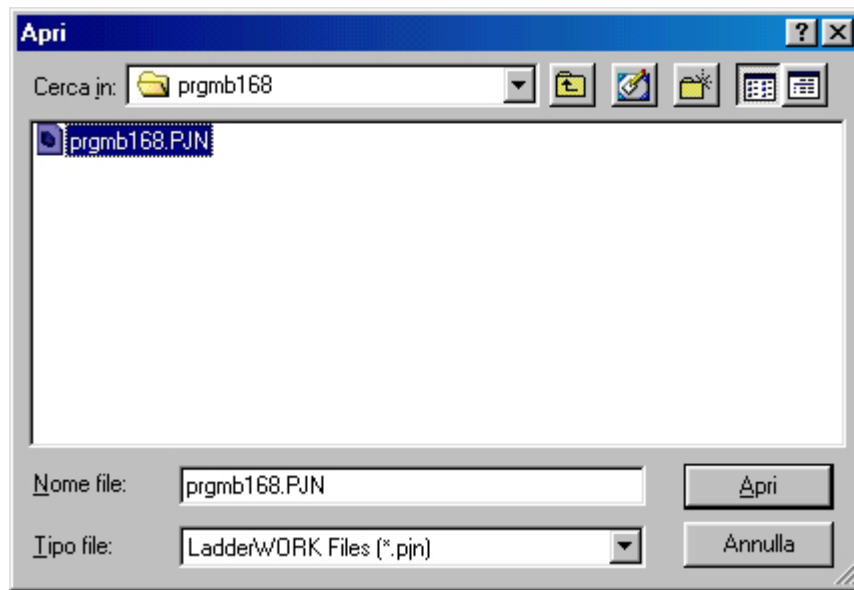
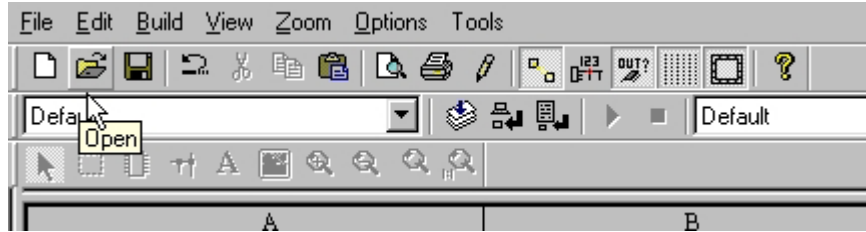

FIGURE 23: LOADING SOURCE SCHEMATIC WITH LADDER WORK

IIIb) Assure that the selected profile is the one specific for **GMM AC Zero**:

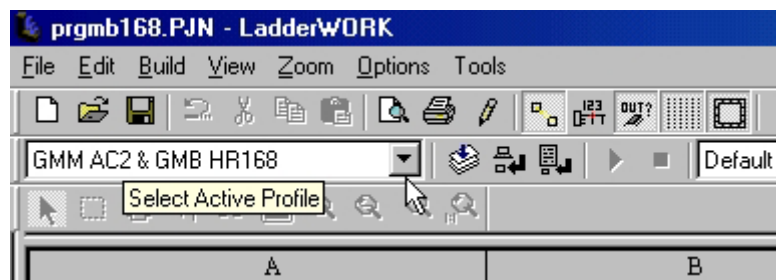

FIGURE 24: COMPILER CONFIGURATION FOR LADDER WORK

IIIc) Compile the source schematic pressing the first button from the right:

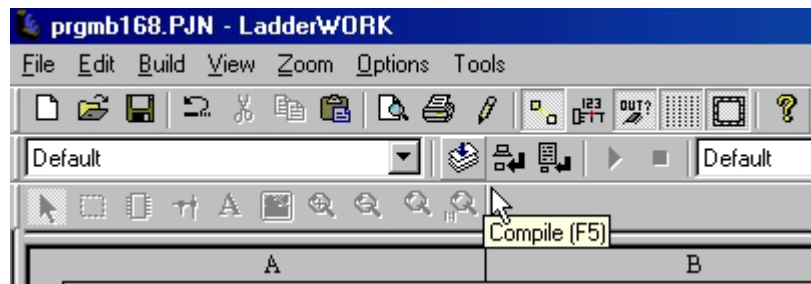

FIGURE 25: COMPILATION WITH LADDER WORK

C4) Repperform the programming of the obtained HEX file in the Mini Module FLASH, by executing again the points B3÷B17.

About the FLASH MAGIC settings, please remind that they could be inserted only the first time in fact the same program maintains the last setting sucesfully used.

When during execution of the steps above described a problem or a malfunction is found, we suggest to read and repeat again all the steps carefully and if malfunction persists please contact directly **grifo**[®] technician.

Instead when execution of all the steps above described is right, the user has realized his first application program that coincides with demo of **GMM AC Zero**.

At this point it is possible to modify the source of the demo/s program according to application requirements and test the obtained program with the steps above listed (from B3 to C4) in cyclic mode, until the developed application program is completely well running.

When this focus is reached the developmnet P.C. can be eliminated, by obtaining a self running card, as below described:

D) FINAL APPLICATION

D1) Set RUN mode (DSW1.1=OFF) and disconnect the PC.

POWER SUPPLY

Mini Module can be supplied with +5 Vdc \pm 5%.

On the board all the circuits and components have been chosen to obtain the best noisy immunity and the lowest consumption, including the possibility to use four different power down setting of the microcontroller. In the best conditions a minimum consumption of 21 mA is reached and it is suitable for portable applications where battery life time is increased.

Detailed information are reported in "ELECTRIC FEATURES" chapter.

MEMORY ARCHITECTURE

Memory of MiniModule **GMM AC Zero** is made by microprocessor internal memories. In detail:

- 64K Bytes FLASH of user memory
- 256 Bytes IRAM of user memory
- 2K Bytes FLASH for boot loader
- 2K Bytes EEPROM of user memory
- 2K Bytes SRAM of user memory

Access to microcontroller internal memory is explained in the component data sheet, so please refer to this latter or to appendix A of this manual for further information.

OPERATING MODE SELECTION

As described on figure 8 and in the previous paragraphs, the dip switches DSW1.1 selects the **GMM AC Zero** Mini Module operating mode. In detail are available two modes relative to the following configurations:

DSW1.1		Operating mode
OFF	->	RUN mode
ON	->	DEBUG mode

In RUN mode after a power on the application program saved in FLASH is always executed, independently by external conditions, while in DEBUG mode the boot loader is always executed. Programs for P.C. as the FLIP (for ISP management of FLASH EPROM) and HYPERTERMINAL (for the console terminal emulation) are able to perform these settings and they make up the only necessary development aids.

The ISP technique (In System Programming) reduces the cost and the time for development in fact it eliminates the use of external EPROMs, programmer, eraser, etc.

For further information on ISP programming please consult the specific technical documentation released by ATMEL.

SERIAL COMMUNICATION SELECTION

Serial line of **GMM AC Zero** can be buffered in RS 232 or TTL.

In case it is buffered in RS 232, line signals are protected against discharges up to ± 15 kV.

By software the serial line can be programmed to operate with all the standard physical protocols, in fact the bits per character, parity, stop bits and baud rates can be decided by setting oportunes microprocessor's internal registers.

By hardware can be selected which one of the electric standards is used, through dip switches configuration, as described in the previous tables; the user can select in autonomy one or the other type by following the information below:

- SERIAL LINE IN RS 232 (default configuration)

DSW1.2	=	ON
DSW1.3	=	ON
DSW1.4	=	OFF
DSW1.5	=	OFF

- SERIAL LINE IN TTL

DSW1.2	=	OFF
DSW1.3	=	OFF
DSW1.4	=	ON
DSW1.5	=	ON

The following figures shows how a generic external system can be connected to **GMM AC Zero** serial line, with both the electric standard.

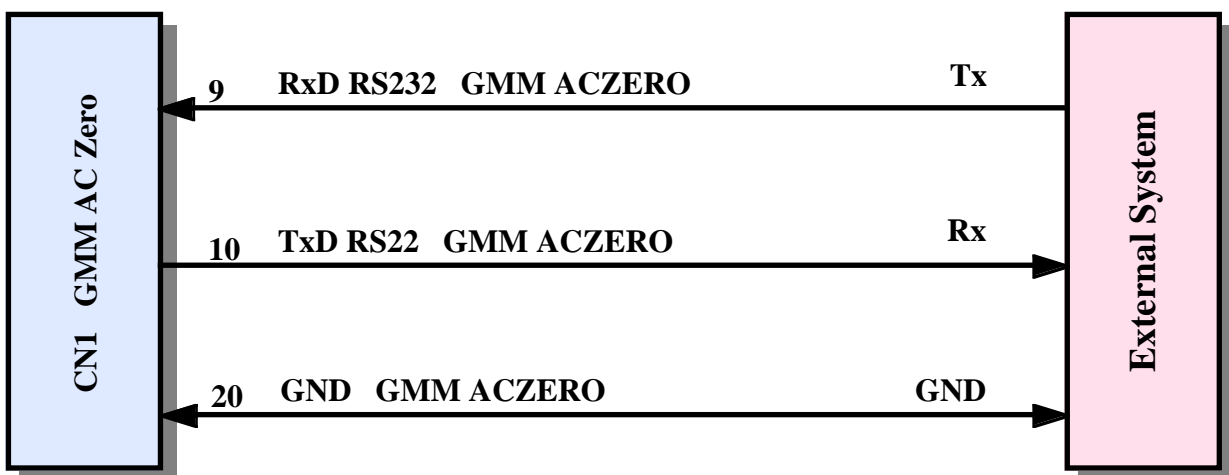

FIGURE 26: EXAMPLE OF RS 232 SERIAL CONNECTION

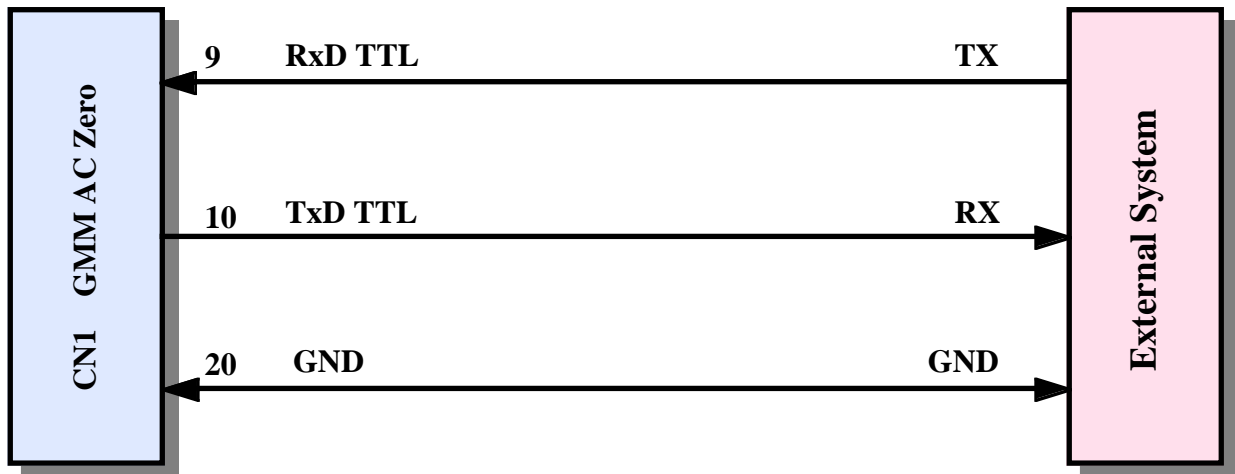

FIGURE 27: EXAMPLE OF TTL CONNECTION

UART CAN

Micocontroller installed on the Mini Module **GMM AC Zero** features a CAN UART compatible to standard 2.0 A and 2.0 B.

Adding to Mini Module a transceiver capable to reach about 1 Mbits/sec (ISO - 11898), it is possible to connect easily the Mini Module to any system provided with the same interface.

As the controller used in inside the micro, it is completely configured and managed through internal registers accessible in the CPU addressing space.

For further information please see the data sheet in appendix A of this manual.

CAN bus must be a differential line with 60 Ω of impedance so termination resistors must be connected to obtain this value.

There can be also two termination resistors (120 Ω) at the extremities of the line.

GMM AC Zero provides no terminaton resistors.

CAN line is galvanically isolated from board supply voltage.

Ground of Mini Module is available on pin 20 of connector CN1.

This latter can be used to equilibrate difference of potentials amongst several CAN systems, but also to shield physical connection, using CAN shielded cable, to obtain the greatest protection against external noise.

SOFTWARE DESCRIPTION

A wide selection of software development tools can be obtained, allowing use of the module as a system for its own development, both in assembler and in other high level languages; in this way the user can easily develop all the requested application programs in a very short time. Generally all software packages available for the mounted microprocessor, or for the 51 family, can be used.

All the software development tools supplied by grifo® always include many example programs, in source and executable format, fully remarked, that shows how to manage each section of the card.

GWT51: Complete communication and mass memories management program for all '51 family cards. Performs an ADD Veiwpoint compliant terminal emulation. Works with Windows 9x/ME, NT, 2000, XP.

GET 51: it is a complete program with editor, communication driver and mass memory management for all '51 family cards. This program developed by grifo® allows to operate in the best conditions. The program is menu driven and mouse driven. It is designed to run undr MS-DOS but can run also in MACINTOSH environment with VIRTUAL-PC. It is delivered in MS-DOS 3"1/2 floppy disks.

BASCOM 8051: cross compiler for BASIC source program. It is a powerful software tool that includes editor, BASIC compiler and simulator included in an easy to use integrated development environment for Windows. Many memory models, data types and direct use of hardware resource instructions are available.

HI TECH C 51: cross compiler for C source program. It is a powerful software tool that includes editor, C compiler, assembler, optimizer, linker, library, and remote symbolic debugger, in one easy to use integrated development environment.

SYS51CW: cross compiler for C source program. It is a powerful software tool that includes editor, C compiler, assembler, optimizer, linker, library, simulator and remote symbolic debugger, included in an easy to use integrated development environment for Windows.

SYS51PW: cross compiler for PASCAL source program. It is a powerful software tool that includes editor, PASCAL compiler, assembler, optimizer, linker, library, simulator and remote symbolic debugger, included in an easy to use integrated development environment for Windows.

DDS MICRO C 51: low cost ross compiler for C source program. It is a powerful software tool that includes editor, C compiler (integer), assembler, optimizer, linker, library, and remote debugger, in one easy to use IDE. Includes the library sources and many utilities programs.

µC/51: It is a comfortable, low cost, software package with a colplete IDE that allows to use an editor, and ANSIC compiler, and assembler, a linker and a remote source level debugger user configurable. Souces of main libraries and remote debugger are included, and so severl utility and demo programs.

LADDERWORK: It is a easy to use system to generate automation application using the very famouts contact logic. It features a graphic editor to place and connect components that refer to hardware resources (like digital I.O, counters, A/D, etc.) like on an electric diagram and define their properties, and efficent compiler to create the executable code and an utility to download it. IDE makes comfortable use of tools. Delivered in a CD for Windows with user manual and hardware key.

PERIPHERAL DEVICES SOFTWARE DESCRIPTION

In the previous paragraphs are described the external registers addresses, while in this one there is a specific description of registers meaning and function (please refer to I/O addressing tables, for the registers name and addresses values).

For microprocessor internal peripheral devices, not described in this paragraph, or for further information, please refer to manufacturing company documentation or appendix A of this manual. In the following paragraphs the **D7÷D0** and **.0÷7** indications denote the eight bits of the combination involved in I/O operations.

CONFIGURATION INPUTS

Three switches of the on board DSW1 dip switch status can be obtained by software, through a simple read operation of bit 5, 6 and 7 of port 2:

P2.7	->	DSW1.6
P2.6	->	DSW1.7
P2.5	->	DSW1.8

DSW1 is read in complemented logic, in fact "ON" position corresponds to logic level **0** and "OFF" position corresponds to logic level **1**.

Switch 1 is the RUN or DEBUG selector, that is if the switch is ON after a reset or a power on the boot loader is run, otherwise if the switch is OFF the user program in internal FLASH is run.

STATUS LEDES

LEDs LD1 (green) and LD2 (red) can be software driven and their status can be read by simple read and write operations on port 2:

P2.6	->	LD1
P2.7	->	LD2

Driving is in complemented logic, in fact LED is **ON** when bit is **0** and LED is **OFF** when the corresponding bit is **1**.

Signals of P2 are kept at logic level 1 during the reset or the power on, so when on these phases happen, LEDs are OFF.

EXTERNAL DEVICES

GMM AC Zero, through board **GMB HR168**, can be connected to a wide range of block modules and operator interface system produced by **grifo**[®], or to many systems of other companies. The on-board resources can be expanded with a simple connection to the numerous peripheral **grifo**[®] boards, both intelligent and not, thanks to its standard I/O **ABACO**[®] connector.

Hereunder some of these cards are briefly described; ask the detailed information directly to **grifo**[®], if required.

GMB HR168

grifo[®] Mini Block Housing, 16 opto inputs, 8 relays outputs

Plastic container for rails DIN 50022 Modulbox model M6 HC53; front 90 x 106; height 58 mm; 16 optocoupled **inputs NPN** or **PNP** visualized through **LEDs**; some inputs can be **counter** or **interrupt** source; **8 relay outputs** up to 5 A visualized through **LEDs**; some outputs can make **PCA** functions for automatic timed commands; **RTC** with Lithium battery; 1 TTL output driven by RTC and visualized through LED.

GMM TST2

grifo[®] Mini Module Test 2

Low price card useful for evaluating and test purpose of 28 or 40 pins **grifo**[®] Mini Modules type **GMM 932**, **GMM AM08** **GMM AM32**, etc... It provides: **D9 connectors** for a direct connection to **RS 232** line and **AVR programmer**; **Buzzer**; Connectors 10 pin for a direct connection to AVR ISP; **16 Key** buttons; 2 lines **LCD** display; **power supply** section with standard connector; push buttons and LEDs for digital I/O signals management; etc.

QTP G28

Quick Terminal Panel - Graphic LCD, 28 keys + CAN

Operator panel with LCD display 240x128 pixels, CFC backlit; Optocoupled RS 232 line and additional RS 232, 422, 485, Current Loop line; CAN line controller and interface; EEPROM for set up; 256K EPROM or FLASH; 128K RAM; RTC and RAM lithium backed; possibility of renaming keys, LEDs and panel name; Buzzer, 28 keys and 16 LEDs with blinking attribute, manageable by software; built in power supply; reader of magnetic badge and relay option. Plastic and metallic container. High level firmware with capabilities of terminal provided of primary graphic objects;

QTP 22

Quick Terminal Panel, 22 LEDs, 22 keys + Badge Reader

Intelligent user panel equipped with Fluorescent or LCD display, LEDs backlit, 40x2 or 40x4 characters; RS 232, RS 422, RS 485 or Current Loop serial line; serial E2 for set up and message. Possibility of re-naming keys, LEDs and panel name by inserting label with new name into the proper slot; 22 Keys and 22 LEDs with blinking attribute and buzzer manageable by software; built in power supply; RTC option, reader of magnetic badge and relay.

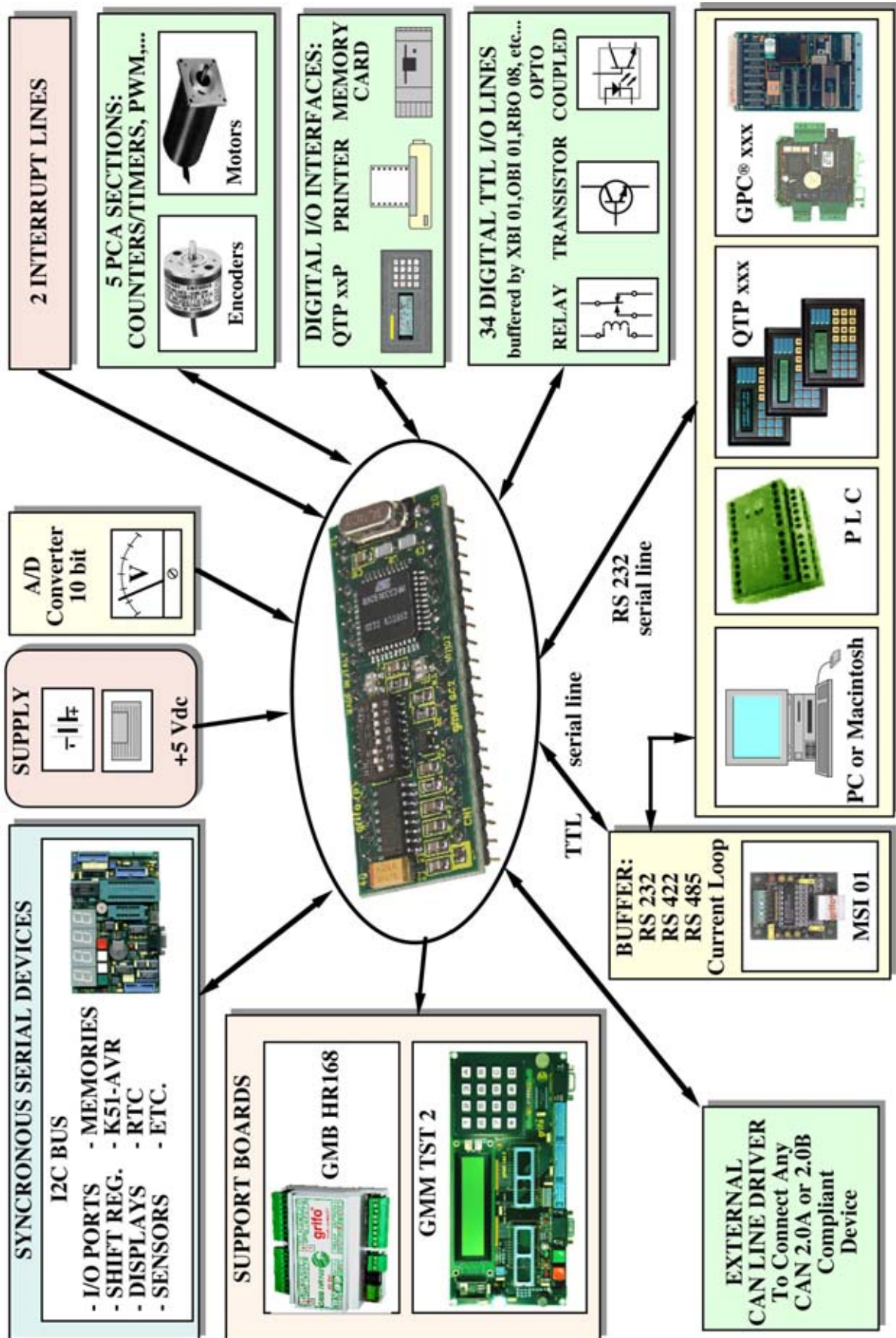

FIGURE 28: CONNECTION EXAMPLES

QTP 24

Quick Terminal Panel, 16 LEDs, 24 keys + Badge Reader

Intelligent user panel equipped with Fluorescent or LCD display, LEDs backlit, 20x2 or 20x4 characters; RS 232, RS 422, RS 485 or Current Loop serial line; serial E2 for set up and message. Possibility of re-naming keys, LEDs and panel name by inserting label with new name into the proper slot; 24 Keys and 16 LEDs with blinking attribute and buzzer manageable by software; built in power supply; RTC option, reader of magnetic badge and relay.

QTP 16

Quick Terminal Panel, 1 LED, 16 keys + 4 Opto Inputs

Intelligent user panel equipped with Fluorescent or LCD display, LEDs backlit, 20x2, 20x4 characters; interface for 16 keys keyboard; serial interface can be buffered in RS 232, RS 422, RS 485 or Current Loop; set up parameters on EEPROM; buzzer; 4 opto-input redable for serial lines. Control firmware performing terminal functions with video management commands.

QTP 12

Quick Terminal Panel, 1 LED, 1 LEDs, 12 keys + CAN

Intelligent user panel equipped with Fluorescent or LCD display, LEDs backlit, 20x2 characters; graphic Fluorescente display 140x16 pixel; interface for 12 keys keyboard; serial interface can be buffered in RS 232, RS 422, RS 485 or Current Loop; CAN interface; set up parameters on EEPROM; buzzer. Control firmware performing terminal functions with video management commands.

QTP 4x6

Quick Terminal Panel, 24 keys max.

Operator interface provided with alphanumeric display 20x2, 20x4, 20x4 BIG, 40x1 and 40x2 characters both LCD and fluorescent; display LCD backlit by LED; interface for tastiera three keys external keyboard; RS 232, RS 422, RS 485 or Current Loop serial line; setup in EEPROM ; buzzer. Management firmware featuring terminal functions with primitives to control visualization.

QTP 03

Quick Terminal Panel, 3 keys max.

Operator interface provided with alphanumeric display 20x2, 20x4, 20x4 BIG, 40x1 and 40x2 characters both LCD and fluorescent; display LCD backlit by LED; interface for tastiera three keys external keyboard; serial interface in RS 232 or TTL; setup in EEPROM ; buzzer. Management firmware featuring terminal functions with primitives to control visualization.

MSI 01

Multi Serial Interface 1 line

Interface for TTL serial line and buffered serial line in RS 232, RS 422, RS 485 or Current Loop. The TTL line is on a screw terminal connector and the buffered one is on a standard plug connector.

BIBLIOGRAPHY

In this chapter there is a complete list of technical books, where the user can find all the necessary documentations on the components mounted on **GMM AC Zero**.

Manual ATMEL:	<i>Data sheet AT89C51CC03</i>
Manual MAXIM:	<i>New Releases Data Book - Volume IV</i>
Manual MAXIM:	<i>New Releases Data Book - Volume V</i>
Technincal documentationMAXIM:	<i>True RS 232 Transceivers</i>

For further information and upgrades please refer to specific internet web pages of the manufacturing companies.

Data sheet della CPU is available also at our technical documentation service:
<http://www.grifo.it/PRESS/DOC/Temic/T89C51CC03.pdf>



APPENDIX A: DATA SHEET

grifo® provides a completely free technical documentation service to make available data sheets of on board components, through its web site. In this chapter the user found the complete and ready to use links and URLs to these information, together with the first pages of the same documents. To use our technical documentation service just connect to our site www.grifo.com and click its icon.

AT89C51CC03

Link: Home | Technical documentation Service | ATMEL | Data-Sheet AT89C51CC03

URL: <http://www.grifo.com/PRESS/DOC/ATMEL/AT99C51CC03.pdf>

Features

- 80C51 Core Architecture
- 256 Bytes of On-chip RAM
- 2048 Bytes of On-chip ERAM
- 64K Bytes of On-chip Flash Memory
 - Data Retention: 10 Years at 85°C
 - Read/Write Cycle: 100K
- 2K Bytes of On-chip Flash for Bootloader
- 2K Bytes of On-chip EEPROM
 - Read/Write Cycle: 100K
- 14-sources 4-level Interrupts
- Three 16-bit Timers/Counters
- Full Duplex UART Compatible 80C51
- Maximum Crystal Frequency 40 MHz
 - In X2 Mode, 20 MHz (CPU Core, 20 MHz)
- Five Ports: 32 + 4 Digital I/O Lines
- Five-channel 16-bit PCA with
 - PWM (8-bit)
 - High-speed Output
 - Timer and Edge Capture
- Double Data Pointer
- 21-bit WatchDog Timer (7 Programmable Bits)
- A 10-bit Resolution Analog to Digital Converter (ADC) with 8 Multiplexed Inputs
- SPI Interface, (PLCC52, VFPF64 and CABGA 64 packages only)
- Full CAN Controller
 - Fully Compliant with CAN Rev 2.0A and 2.0B
 - Optimized Structure for Communication Management (Via SFR)
 - 15 Independent Message Objects
 - Each Message Object Programmable on Transmission or Reception
 - Individual Tag and Mask Filters up to 29-bit Identifier/Channel
 - 8-byte Cyclic Data Register (FIFO)/Message Object
 - 16-bit Status and Control Register/Message Object
 - 16-bit Time-Stamping Register/Message Object
 - CAN Specification 2.0 Part A or 2.0 Part B Programmable for Each Message Object
 - Access to Message Object Control and Data Registers Via SFR
 - Programmable Reception Buffer Length Up To 15 Message Objects
 - Priority Management of Reception of Hits on Several Message Objects at the Same Time (Basic CAN Feature)
 - Priority Management for Transmission
 - Message Object Overrun Interrupt
 - Supports
 - Time Triggered Communication
 - Autobaud and Listening Mode
 - Programmable Automatic Reply Mode
 - 1-Mbit/s Maximum Transfer Rate at 8 MHz⁽¹⁾ Crystal Frequency in X2 Mode
 - Readable Error Counters
 - Programmable Link to On-chip Timer for Time Stamping and Network Synchronization
 - Independent Baud Rate Prescaler
 - Data, Remote, Error and Overload Frame Handling
- On-chip Emulation Logic (Enhanced Hook System)
- Power Saving Modes
 - Idle Mode
 - Power-down Mode

1. At BRP = 1 sampling point will be fixed.



**Enhanced 8-bit
MCU with CAN
Controller and
Flash Memory**

AT89C51CC03

**Advance
Information**

Rev. 4182A-CAN-07/03





- Power Supply: 3 volts to 5.5 volts
- Temperature Range: Industrial (-40° to +85°C)
- Packages: VQFP44, PLCC44, VQFP64, PLCC52, CA-BGA64

Description

The AT89C51CC03 is the third member of the CANary™ family of 8-bit microcontrollers dedicated to CAN network applications.

In X2 mode a maximum external clock rate of 20 MHz reaches a 300 ns cycle time.

Besides the full CAN controller AT89C51CC03 provides 64K Bytes of Flash memory including In-System Programming (ISP), 2K Bytes Boot Flash Memory, 2K Bytes EEPROM and 2048 byte ERAM.

Primary attention is paid to the reduction of the electro-magnetic emission of AT89C51CC03.

Block Diagram

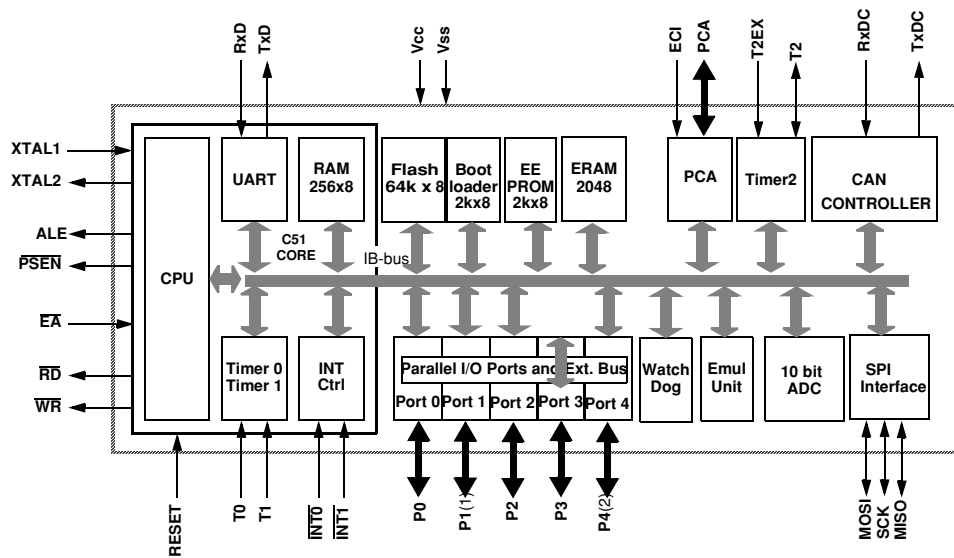

- Notes: 1. 8 analog Inputs/8 Digital I/O
2. 5-Bit I/O Port



APPENDIX B: GMM TST 2 ELECTRIC DIAGRAM

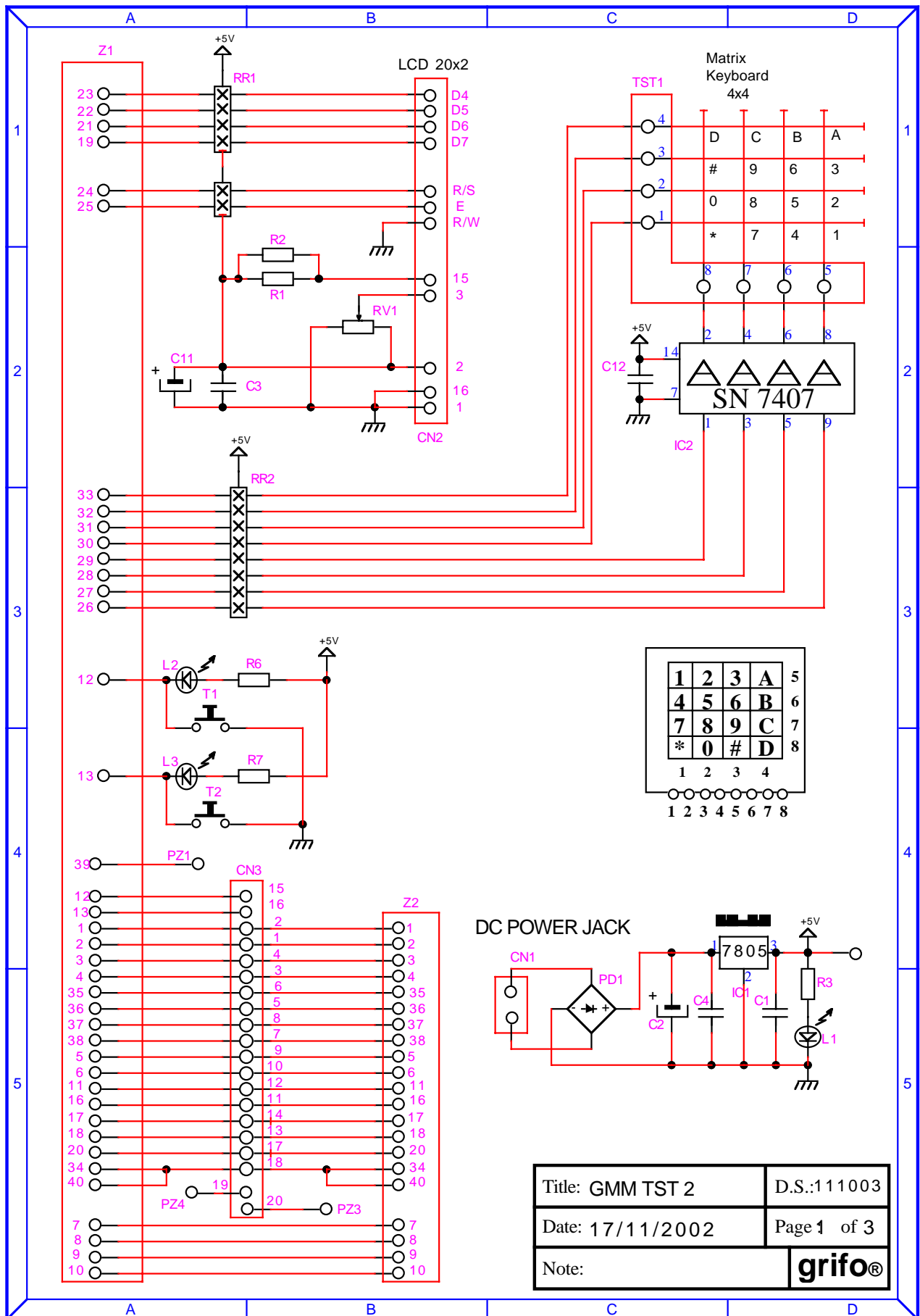

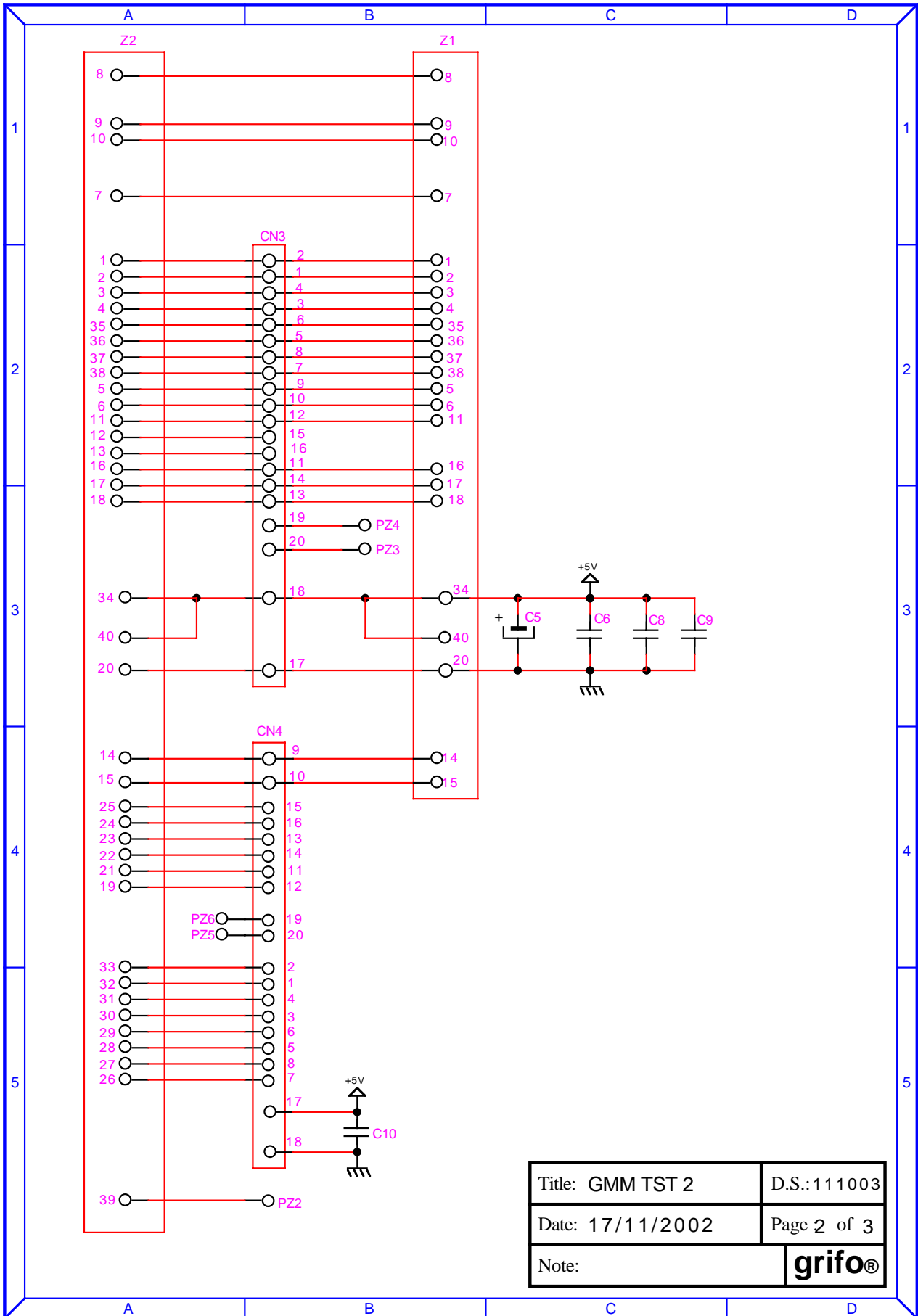

Title: GMM TST 2	D.S.: 111003
Date: 17/11/2002	Page 2 of 3
Note:	grifo®



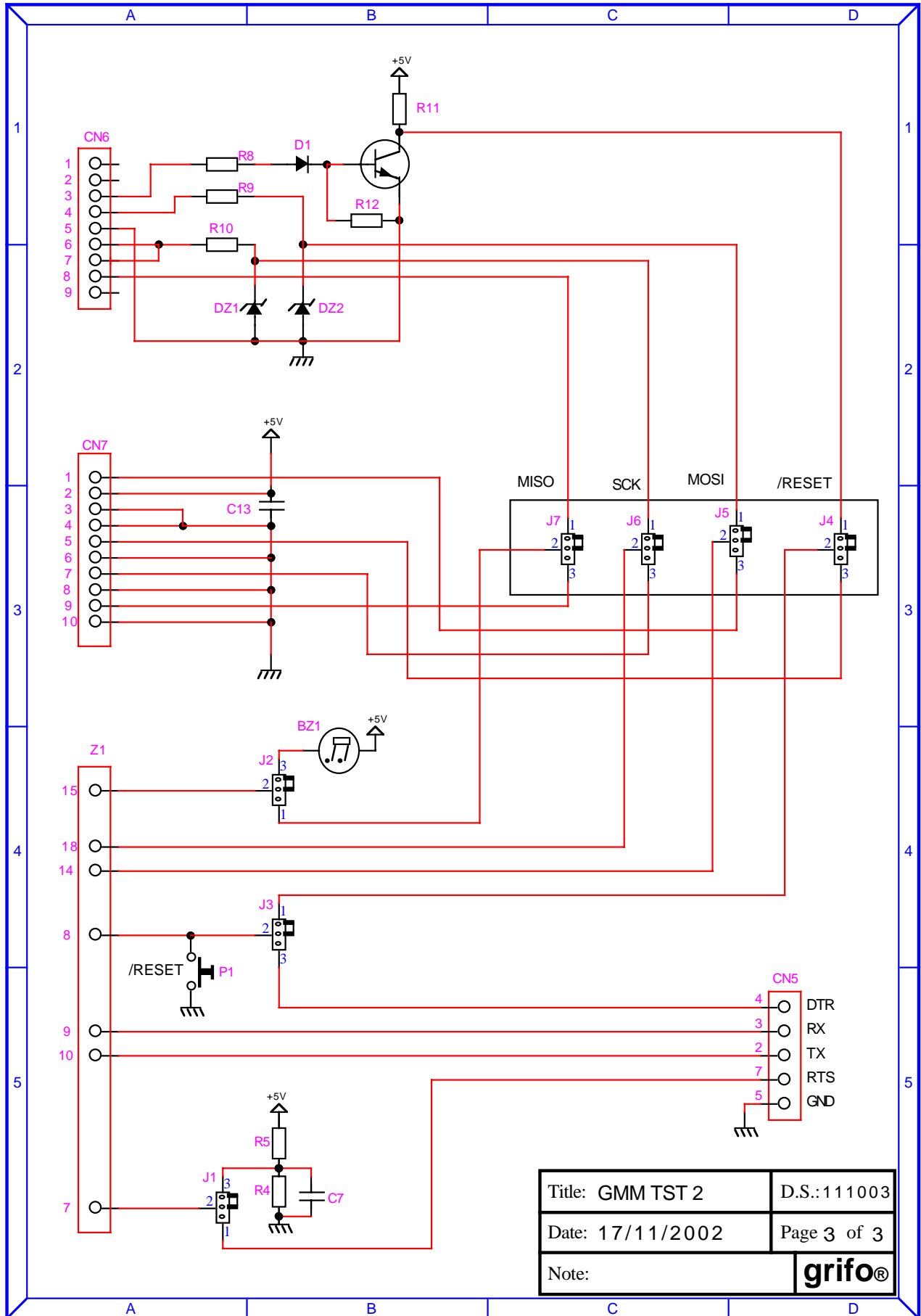

Title: GMM TST 2	D.S.: 111003
Date: 17/11/2002	Page 3 of 3
Note:	grifo®





APPENDIX C: ALPHABETICAL INDEX

SYMBOLS $\mu\text{C}/51$ 34**A**

A/D CONVERTER 10

A/D CONVERSION TIME 10

A/D RESOLUTION 10

ANALOG INPUTS 13

ANALOG INPUTS IMPEDANCE 11

ANALOG INPUTS VOLTAGE RANGE 11

REFERENCE VOLTAGE 13

B

BASCOM 8051 34

BIBLIOGRAPHY 39

C

CAN 10, 33

CLOCK 10

CPU 10

CURRENT CONSUMPTION 11

D

DEBUG 15, 31

DIP SWITCH 10, 14, 31, 35

DISPLAY LCD 20

DSW 31

E

EEPROM 31

F

FLASH 31

G

GMB HR168 18

GMM TST 2 20, 21

I

I/O SIGNALS 10
I²C BUS 14
INTERRUPT 10, 13, 16
IRAM 31

L

LADDERWORK 34
LEDS 10, 12, 15, 35

M

MATRIX KEYBOARD 20

O

OPTOCOUPLED INPUTS 18

P

PCA 10, 13
POWER FAILURE THRESHOLD 11
POWER ON TIME 10
POWER SUPPLY 11, 31

R

RAM 31
REAL TIME CLOCK (OPTIONAL) 18
RELATIVE HUMIDITY 10
RELAY OUTPUTS 18
RESET 10
RS 232 10, 13, 14, 15, 32
RUN 15, 31

S

SERIAL COMMUNICATION SELECTION 32
SIZE 10
SRAM 31

T

TEMPERATURE RANGE 10
TIMER/COUNTER 10, 13
TTL 13, 14, 32

W

WATCH DOG **10**

WEIGHT **10**

X

X2 MODE **8**

